



Page 9-2

PLASTIC LIMIT SWITCHES KB-KC TYPES

- Dimensions to EN 50047 standards for KB type
- Dimensions compatible to EN 50047 for KC type
- Self-extinguishing polymer thermoplastic housing
- Removable and interchangeable auxiliary contact blocks
- Bi-directional versions
- Unique fixing mechanism of operating head
- IEC degree of protection IP65
- M20 cable entry; PG13.5 or 1/2 NPT entry available.



Page 9-2

METAL LIMIT SWITCHES KM-KN TYPES

- Dimensions to EN 50047 standards for KM type
- Dimensions compatible to EN 50047 for KN type
- Aluminium-zinc alloy housing
- Removable and interchangeable auxiliary contact blocks
- Bi-directional versions
- Unique fixing mechanism of operating head
- IEC degree of protection IP65
- M20 cable entry; PG13.5 or 1/2 NPT entry available.



Page 9-18

PREWIRED METAL LIMIT SWITCHES KP TYPE

- Dimensions to EN 50047 standards
- 2 metre long cable
- IEC degree of protection IP67.



Page 9-19

PLASTIC LIMIT SWITCHES T SERIES

- Dimensions to EN 50041 standards
- Self-extinguishing polymer thermoplastic housing
- Heads rotatable in 4 different 90° angle positions
- IEC degree of protection IP66
- PG13.5 cable entry.



Page 9-21

METAL LIMIT SWITCHES PL SERIES

- Aluminium-zinc alloy housing
- Maximum of 2 auxiliary contacts
- IEC degree of protection IP40 and IP65
- PG11 cable entry.



Page 9-23

ROPE-PULL LEVER LIMIT SWITCHES FOR NORMAL STOPPING

- Self-extinguishing polymer thermoplastic housing
- Aluminium-zinc alloy housing
- IEC degree of protection IP40, IP65 and IP66
- PG11 and PG13.5 cable entry.



Page 9-25

ROPE-PULL LEVER LIMIT SWITCHES FOR EMERGENCY STOPPING

- Compliant to ISO 13850 standards
- IEC degree of protection IP65 and IP66
- PG11 and PG13.5 cable entry.



Page 9-26

PLASTIC MICRO SWITCHES KS TYPE

- Polymer thermoplastic housing
- Changeover contact switch
- IEC degree of protection IP00 or IP20.



Page 9-27

FOOT SWITCHES

- Versions with or without protection cover
- Self-extinguishing polymer thermoplastic housing
- Aluminium-zinc alloy housing
- IEC degree of protection IP54 and IP65
- M20 cable entry.



- Dimensions to EN 50047 standards
- Dimensions compatible to EN 50047
- Dimensions to EN 50041 standards
- Direct opening action of NC contacts
- Extensive range of operating heads
- Versions complete with interchangeable and rotatable heads
- Versions with removable and interchangeable auxiliary contact blocks.

Metal and plastic limit switches, K series (dimensions to/compatible to EN 50047)

SEC. - PAGE

Top push rod plunger	9 - 2
Top roller push plunger	9 - 3
Roller centre push lever	9 - 4
Roller side push lever	9 - 5
Roller lever	9 - 6
Adjustable roller lever	9 - 8
Ceramic rod lever	9 - 10
Adjustable rod lever	9 - 11
Wobble stick, omnidirectional	9 - 12
Hinge operating	9 - 13
Slotted lever	9 - 14
Key operated	9 - 15
Accessories and spare parts	9 - 16
Prewired metal limit switches, K series	9 - 18
Plastic limit switches T series (dimensions to EN 50041)	
Top push rod plunger and roller lever	9 - 19
Wobble stick, omnidirectional and key operated	9 - 20
Metal limit switches, PL series	
Top push rod plunger, top roller push plunger, roller centre push lever	9 - 21
Latch and manual release	9 - 22
Manual reload and magnetic release	9 - 22
Bi-directional	9 - 22
Rope-pull lever limit switches for normal stopping	9 - 23
Rope-pull lever limit switches for emergency stopping, ISO 13850 compliant	9 - 25
Plastic micro switches, K series	9 - 26
Foot switches, K series	9 - 27
Dimensions	9 - 28
Wiring diagrams	9 - 35

Limit, micro and foot switches

Limit switches, K series. One bottom cable entry. Dimensions to EN 50047
Two side cable entries. Dimensions compatible to EN 50047

Top push rod plunger



KB A... - KM A...

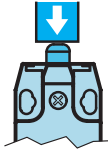

KC A... - KN A...

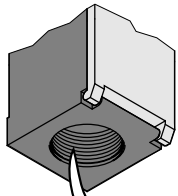

M20 CABLE ENTRY

For types with PG13.5 cable entry, add the letter P at the end of the order code while for 1/2 NPT, add N. E.g. KBA1S11P - KBA1S11N

Order code	Plastic body	Metal body	Contacts	Plunger material	Qty per pkg	Wt [kg]
One bottom cable entry. Dimensions to EN 50047.						
KB A1 S11	KM A1 S11		1NO+1NC Snap action Ⓢ	Metal	5	Ⓢ
KB A1 S02	KM A1 S02		2NC Snap action Ⓢ	Metal	5	Ⓢ
KB A1 A11	KM A1 A11		1NO+1NC Slow action make before break Ⓢ	Metal	5	Ⓢ
KB A1 L11	KM A1 L11		1NO+1NC Slow action Ⓢ	Metal	5	Ⓢ
KB A1 L02	KM A1 L02		2NC Slow action Ⓢ	Metal	5	Ⓢ
KB A1 L20	KM A1 L20		2NO Slow action	Metal	5	Ⓢ
KB A1 L12	KM A1 L12		1NO+2NC Slow action Ⓢ	Metal	5	Ⓢ
KB A1 L21	KM A1 L21		2NO+1NC Slow action Ⓢ	Metal	5	Ⓢ
KB A1 L03	KM A1 L03		3NC Slow action Ⓢ	Metal	5	Ⓢ
Two side cable entries. Dimensions compatible to EN 50047.						
KC A1 S11	KN A1 S11		1NO+1NC Snap action Ⓢ	Metal	5	Ⓢ
KC A1 S02	KN A1 S02		2NC Snap action Ⓢ	Metal	5	Ⓢ
KC A1 A11	KN A1 A11		1NO+1NC Slow action make before break Ⓢ	Metal	5	Ⓢ
KC A1 L11	KN A1 L11		1NO+1NC Slow action Ⓢ	Metal	5	Ⓢ
KC A1 L02	KN A1 L02		2NC Slow action Ⓢ	Metal	5	Ⓢ
KC A1 L20	KN A1 L20		2NO Slow action	Metal	5	Ⓢ

Ⓢ Direct (positive) opening action Ⓢ safety function according to IEC/EN 60947-5-1.

Ⓢ Consult Customer Service for information; see contact details on inside front cover.

General characteristics

The LOVATO ELECTRIC limit switches have been designed to satisfy requirements comprising quick installation, easy wiring, simple setup, modularity, sturdiness and constant reliability. The body cover is hinged at the bottom and removable. The innovative locking bayonet mechanism permits to remove and reposition the operating head in the required configuration with no tools. The auxiliary contact blocks are removable assuring remarkable wiring ease.

Operational characteristics

- Maximum operating rate: 3600 cycles/h
- Switching speed: 0.5...1.5m/s
- Mechanical life: >10 million cycles
- IEC conventional thermal current Ith: 10A
- UL/CSA and IEC/EN 60947-5-1 designation:
 - A600 Q300 for KB-KC types
 - A300 Q300 for KM-KN types
- IEC rated insulation voltage Ui:
 - 690VAC for KB-KC types
 - 440VAC for KM-KN types
- IEC rated impulse withstand voltage Uimp:
 - 6kV for KB-KC types
 - 4kV for KM-KN types
- Class II insulation for KB-KC only
- Contact resistance: <10mΩ
- Short-circuit backup protection: 10A gG/SC quick fuse
- Operators of aluminium-zinc alloy
- Housing:
 - KB-KC types - Self-extinguishing double-insulation polymer thermoplastic
 - KM-KN types - Aluminium-zinc alloy
- Cable entry: M20 standard supplied; PG13.5 and 1/2 NPT available (see the side note for details)
- Operating head fixing: Locking bayonet insert
- Operating force: 5N / 1.1lb
- Cable connection: Self-releasing screw terminal
- Tightening torque:
 - Switch fixing: 2.5Nm / 22.1lbin
 - Contact terminals: 0.8Nm / 7lbin
 - Body lid screw fixing: 0.8Nm / 7lbin
- Conductor section: 1 or 2 2.5mm² max / 16-14 AWG
- Ambient conditions:
 - Operating temperature: -25...+70°C
 - Storage temperature: -40...+70°C
 - Pollution degree: 3
 - IEC degree of protection: IP20 for terminals
 - IEC degree of protection: IP65 for body housing.

Certifications and compliance

Certifications obtained: EAC, CCC; UL Listed for USA and Canada (cULus - File E93601), as Auxiliary Devices - Limit switches.

Compliant with standards: EN 50047, IEC/EN 60947-1, IEC/EN 60947-5-1, IEC/EN 60204-1, UL508, CSA C22.2 n° 14.

- ▶ Forward travel of snap action contacts
- ◀ Return travel of snap action contacts

□ open
■ closed

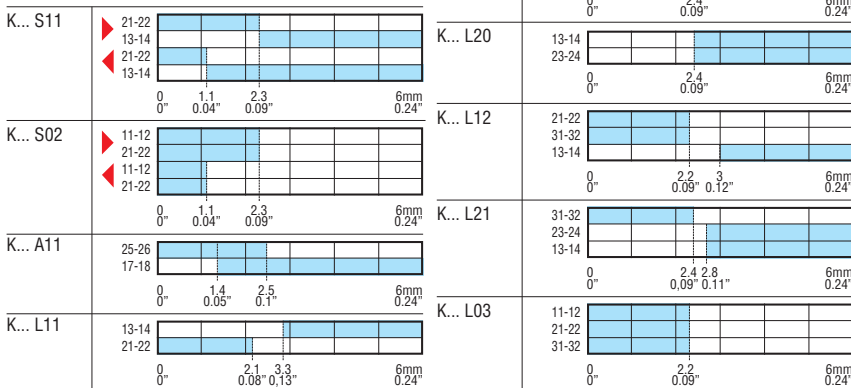

Limit, micro and foot switches

Limit switches, K series. One bottom cable entry. Dimensions to EN 50047
Two side cable entries. Dimensions compatible to EN 50047

Top roller push plunger



KB B... - KM B...

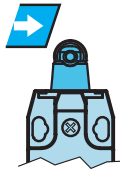

KC B... - KN B...

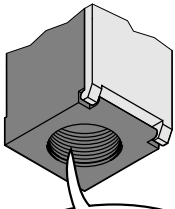

M20 CABLE ENTRY

For types with PG13.5 cable entry, add the letter P at the end of the order code while for 1/2 NPT, add N. E.g. KBB1S11P - KBB1S11N

Order code	Plastic body	Metal body	Contacts	Roller material	Qty per pkg	Wt [kg]
				Ø11x4	n°	[kg]

One bottom cable entry. Dimensions to EN 50047.

KB B1 S11	KM B1 S11	1NO+1NC	Plastic	5	⊕
KB B2 S11	KM B2 S11	Snap action ⊕	Metal	5	⊕
KB B1 S02	KM B1 S02	2NC	Plastic	5	⊕
KB B2 S02	KM B2 S02	Snap action ⊕	Metal	5	⊕
KB B1 A11	KM B1 A11	1NO+1NC	Plastic	5	⊕
KB B2 A11	KM B2 A11	Slow action make before break ⊕	Metal	5	⊕
KB B1 L11	KM B1 L11	1NO+1NC	Plastic	5	⊕
KB B2 L11	KM B2 L11	Slow action ⊕	Metal	5	⊕
KB B1 L02	KM B1 L02	2NC	Plastic	5	⊕
KB B2 L02	KM B2 L02	Slow action ⊕	Metal	5	⊕
KB B1 L20	KM B1 L20	2NO	Plastic	5	⊕
KB B2 L20	KM B2 L20	Slow action	Metal	5	⊕
KB B1 L12	KM B1 L12	1NO+2NC	Plastic	5	⊕
KB B2 L12	KM B2 L12	Slow action ⊕	Metal	5	⊕
KB B1 L21	KM B1 L21	2NO+1NC	Plastic	5	⊕
KB B2 L21	KM B2 L21	Slow action ⊕	Metal	5	⊕
KB B1 L03	KM B1 L03	3NC	Plastic	5	⊕
KB B2 L03	KM B2 L03	Slow action ⊕	Metal	5	⊕

Two side cable entries. Dimensions compatible to EN 50047.

KC B1 S11	KN B1 S11	1NO+1NC	Plastic	5	⊕
KC B2 S11	KN B2 S11	Snap action ⊕	Metal	5	⊕
KC B1 S02	KN B1 S02	2NC	Plastic	5	⊕
KC B2 S02	KN B2 S02	Snap action ⊕	Metal	5	⊕
KC B1 A11	KN B1 A11	1NO+1NC	Plastic	5	⊕
KC B2 A11	KN B2 A11	Slow action make before break ⊕	Metal	5	⊕
KC B1 L11	KN B1 L11	1NO+1NC	Plastic	5	⊕
KC B2 L11	KN B2 L11	Slow action ⊕	Metal	5	⊕
KC B1 L02	KN B1 L02	2NC	Plastic	5	⊕
KC B2 L02	KN B2 L02	Slow action ⊕	Metal	5	⊕
KC B1 L20	KN B1 L20	2NO	Plastic	5	⊕
KC B2 L20	KN B2 L20	Slow action	Metal	5	⊕

⊕ Direct (positive) opening action ⊖; safety function according to IEC/EN 60947-5-1.

⊕ Consult Customer Service for information; see contact details on inside front cover.

Ø11x4mm = Ø0.43x0.16".

General characteristics

The LOVATO ELECTRIC limit switches have been designed to satisfy requirements comprising quick installation, easy wiring, simple setup, modularity, sturdiness and constant reliability.

The body cover is hinged at the bottom and removable. The innovative locking bayonet mechanism permits to remove and reposition the operating head in the required configuration with no tools. The heads have axial rotation of 45° angles.

The auxiliary contact blocks are removable assuring remarkable wiring ease.

Operational characteristics

- Maximum operating rate: 3600 cycles/h
- Switching speed: 0.5...1.5m/s
- Mechanical life: >10 million cycles
- IEC conventional thermal current Ith: 10A
- UL/CSA and IEC/EN 60947-5-1 designation:
 - A600 Q300 for KB-KC types
 - A300 Q300 for KM-KN types
- IEC rated insulation voltage Ui:
 - 690VAC for KB-KC types
 - 440VAC for KM-KN types
- IEC rated impulse withstand voltage Uimp:
 - 6kV for KB-KC types
 - 4kV for KM-KN types
- Class II insulation for KB-KC only
- Contact resistance: <10mΩ
- Short-circuit backup protection: 10A gG/SC quick fuse
- Operators of aluminium-zinc alloy
- Housing:
 - KB-KC types - Self-extinguishing double-insulation polymer thermoplastic
 - KM-KN types - Aluminium-zinc alloy
- Cable entry: M20 standard supplied; PG13.5 and 1/2 NPT available (see the side note for details)
- Operating head fixing: Locking bayonet insert
- Operating force: 5N / 1.1lb
- Cable connection: Self-releasing screw terminal
- Tightening torque:
 - Switch fixing: 2.5Nm / 22.1lbin
 - Contact terminals: 0.8Nm / 7lbin
 - Body lid screw fixing: 0.8Nm / 7lbin
- Conductor section: 1 or 2 2.5mm² max / 16-14 AWG
- Ambient conditions:
 - Operating temperature: -25...+70°C
 - Storage temperature: -40...+70°C
 - Pollution degree: 3
 - IEC degree of protection: IP20 for terminals
 - IEC degree of protection: IP65 for body housing.

Certifications and compliance

Certifications obtained: EAC, CCC; UL Listed for USA and Canada (cULus - File E93601), as Auxiliary Devices - Limit switches.

Compliant with standards: EN 50047, IEC/EN 60947-1, IEC/EN 60947-5-1, IEC/EN 60204-1, UL508, CSA C22.2 n° 14.

- ▶ Forward travel of snap action contacts
- ◀ Return travel of snap action contacts

□ open

■ closed

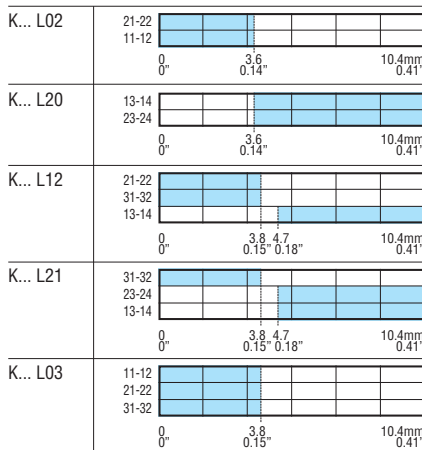
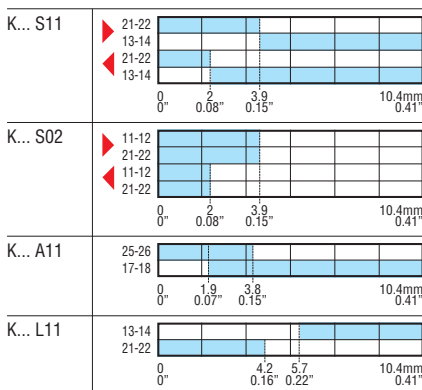

Limit, micro and foot switches

Limit switches, K series. One bottom cable entry. Dimensions to EN 50047
Two side cable entries. Dimensions compatible to EN 50047

Roller centre push lever



KB C... - KM C...



Order code	Plastic body	Metal body	Contacts	Roller material	Qty per pkg	Wt [kg]
				Ø14x5	n°	[kg]

One bottom cable entry. Dimensions to EN 50047.

KB C1 S11	KM C1 S11	1NO+1NC	Plastic	5	⊕
KB C2 S11	KM C2 S11	Snap actionⓈ	Metal	5	⊕
KB C1 S02	KM C1 S02	2NC	Plastic	5	⊕
KB C2 S02	KM C2 S02	Snap actionⓈ	Metal	5	⊕
KB C1 A11	KM C1 A11	1NO+1NC	Plastic	5	⊕
KB C2 A11	KM C2 A11	Slow action make before breakⓈ	Metal	5	⊕
KB C1 L11	KM C1 L11	1NO+1NC	Plastic	5	⊕
KB C2 L11	KM C2 L11	Slow actionⓈ	Metal	5	⊕
KB C1 L02	KM C1 L02	2NC	Plastic	5	⊕
KB C2 L02	KM C2 L02	Slow actionⓈ	Metal	5	⊕
KB C1 L20	KM C1 L20	2NO	Plastic	5	⊕
KB C2 L20	KM C2 L20	Slow action	Metal	5	⊕
KB C1 L12	KM C1 L12	1NO+2NC	Plastic	5	⊕
KB C2 L12	KM C2 L12	Slow actionⓈ	Metal	5	⊕
KB C1 L21	KM C1 L21	2NO+1NC	Plastic	5	⊕
KB C2 L21	KM C2 L21	Slow actionⓈ	Metal	5	⊕
KB C1 L03	KM C1 L03	3NC	Plastic	5	⊕
KB C2 L03	KM C2 L03	Slow actionⓈ	Metal	5	⊕

Two side cable entries. Dimensions compatible to EN 50047.

KC C1 S11	KN C1 S11	1NO+1NC	Plastic	5	⊕
KC C2 S11	KN C2 S11	Snap actionⓈ	Metal	5	⊕
KC C1 S02	KN C1 S02	2NC	Plastic	5	⊕
KC C2 S02	KN C2 S02	Snap actionⓈ	Metal	5	⊕
KC C1 A11	KN C1 A11	1NO+1NC	Plastic	5	⊕
KC C2 A11	KN C2 A11	Slow action make before breakⓈ	Metal	5	⊕
KC C1 L11	KN C1 L11	1NO+1NC	Plastic	5	⊕
KC C2 L11	KN C2 L11	Slow actionⓈ	Metal	5	⊕
KC C1 L02	KN C1 L02	2NC	Plastic	5	⊕
KC C2 L02	KN C2 L02	Slow actionⓈ	Metal	5	⊕
KC C1 L20	KN C1 L20	2NO	Plastic	5	⊕
KC C2 L20	KN C2 L20	Slow action	Metal	5	⊕

Ⓢ Direct (positive) opening action ⊕; safety function according to IEC/EN 60947-5-1.

⊕ Consult Customer Service for information; see contact details on inside front cover.

Ø14x5mm = Ø0.55x0.2".



KC C... - KN C...

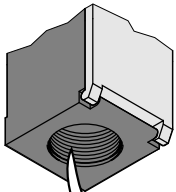

M20 CABLE ENTRY

For types with PG13.5 cable entry, add the letter P at the end of the order code while for 1/2 NPT, add N. E.g. KBC1S11P - KBC1S11N

General characteristics

The LOVATO ELECTRIC limit switches have been designed to satisfy requirements comprising quick installation, easy wiring, simple setup, modularity, sturdiness and constant reliability. The body cover is hinged at the bottom and removable. The innovative locking bayonet mechanism permits to remove and reposition the operating head in the required configuration with no tools. The heads have axial rotation of 45° angles. The auxiliary contact blocks are removable assuring remarkable wiring ease.

Operational characteristics

- Maximum operating rate: 3600 cycles/h
- Switching speed: 0.5...1.5m/s
- Mechanical life: >10 million cycles
- IEC conventional thermal current Ith: 10A
- UL/CSA and IEC/EN 60947-5-1 designation:
 - A600 Q300 for KB-KC types
 - A300 Q300 for KM-KN types
- IEC rated insulation voltage Ui:
 - 690VAC for KB-KC types
 - 440VAC for KM-KN types
- IEC rated impulse withstand voltage Uimp:
 - 6kV for KB-KC types
 - 4kV for KM-KN types
- Class II insulation for KB-KC only
- Contact resistance: <10mΩ
- Short-circuit backup protection: 10A gG/SC quick fuse
- Operators of aluminium-zinc alloy
- Housing:
 - KB-KC types - Self-extinguishing double-insulation polymer thermoplastic
 - KM-KN types - Aluminium-zinc alloy
- Cable entry: M20 standard supplied; PG13.5 and 1/2 NPT available (see the side note for details)
- Operating head fixing: Locking bayonet insert
- Operating force: 6N / 1.34lb
- Cable connection: Self-releasing screw terminal
- Tightening torque:
 - Switch fixing: 2.5Nm / 22.1lbin
 - Contact terminals: 0.8Nm / 7lbin
 - Body lid screw fixing: 0.8Nm / 7lbin
- Conductor section: 1 or 2 2.5mm² max / 16-14 AWG
- Ambient conditions:
 - Operating temperature: -25...+70°C
 - Storage temperature: -40...+70°C
 - Pollution degree: 3
 - IEC degree of protection: IP20 for terminals
 - IEC degree of protection: IP65 for body housing.

Certifications and compliance

Certifications obtained: EAC, CCC; UL Listed for USA and Canada (cULus - File E93601), as Auxiliary Devices - Limit switches. Compliant with standards: EN 50047, IEC/EN 60947-1, IEC/EN 60947-5-1, IEC/EN 60204-1, UL508, CSA C22.2 n° 14.

- ▶ Forward travel of snap action contacts
- ◀ Return travel of snap action contacts

□ open
■ closed

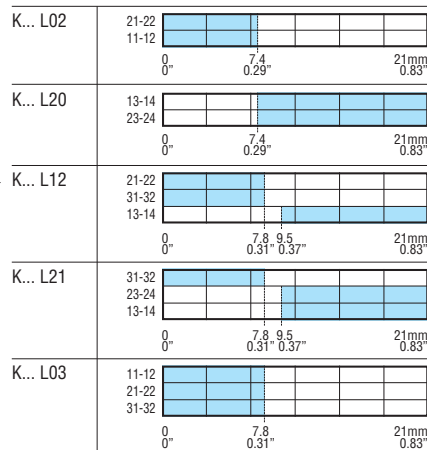
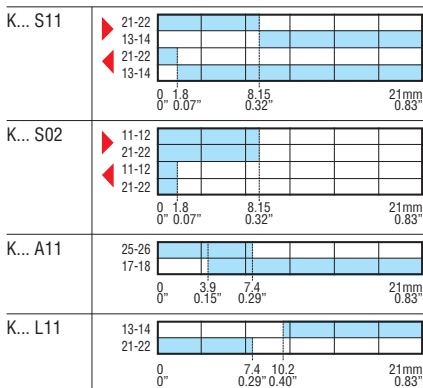

Limit, micro and foot switches

Limit switches, K series. One bottom cable entry. Dimensions to EN 50047
Two side cable entries. Dimensions compatible to EN 50047

Roller side push lever



KB D... - KM D...

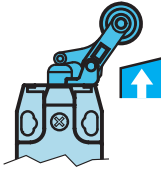

KC D... - KN D...

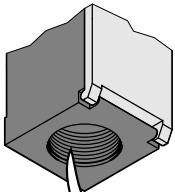

M20 CABLE ENTRY

For types with PG13.5 cable entry, add the letter P at the end of the order code while for 1/2 NPT, add N. E.g. KBD1S11P - KBD1S11N

Order code	Plastic body	Metal body	Contacts	Roller material	Qty per pkg	Wt [kg]
				Ø14x5	n°	[kg]

One bottom cable entry. Dimensions to EN 50047.

KB D1 S11	KM D1 S11	1NO+1NC	Plastic	5	⊕
KB D2 S11	KM D2 S11	Snap action	Metal	5	⊕
KB D1 S02	KM D1 S02	2NC	Plastic	5	⊕
KB D2 S02	KM D2 S02	Snap action	Metal	5	⊕
KB D1 A11	KM D1 A11	1NO+1NC	Plastic	5	⊕
KB D2 A11	KM D2 A11	Slow action make before break	Metal	5	⊕
KB D1 L11	KM D1 L11	1NO+1NC	Plastic	5	⊕
KB D2 L11	KM D2 L11	Slow action	Metal	5	⊕
KB D1 L02	KM D1 L02	2NC	Plastic	5	⊕
KB D2 L02	KM D2 L02	Slow action	Metal	5	⊕
KB D1 L20	KM D1 L20	2NO	Plastic	5	⊕
KB D2 L20	KM D2 L20	Slow action	Metal	5	⊕
KB D1 L12	KM D1 L12	1NO+2NC	Plastic	5	⊕
KB D2 L12	KM D2 L12	Slow action	Metal	5	⊕
KB D1 L21	KM D1 L21	2NO+1NC	Plastic	5	⊕
KB D2 L21	KM D2 L21	Slow action	Metal	5	⊕
KB D1 L03	KM D1 L03	3NC	Plastic	5	⊕
KB D2 L03	KM D2 L03	Slow action	Metal	5	⊕

Two side cable entries. Dimensions compatible to EN 50047.

KC D1 S11	KN D1 S11	1NO+1NC	Plastic	5	⊕
KC D2 S11	KN D2 S11	Snap action	Metal	5	⊕
KC D1 S02	KN D1 S02	2NC	Plastic	5	⊕
KC D2 S02	KN D2 S02	Snap action	Metal	5	⊕
KC D1 A11	KN D1 A11	1NO+1NC	Plastic	5	⊕
KC D2 A11	KN D2 A11	Slow action make before break	Metal	5	⊕
KC D1 L11	KN D1 L11	1NO+1NC	Plastic	5	⊕
KC D2 L11	KN D2 L11	Slow action	Metal	5	⊕
KC D1 L02	KN D1 L02	2NC	Plastic	5	⊕
KC D2 L02	KN D2 L02	Slow action	Metal	5	⊕
KC D1 L20	KN D1 L20	2NO	Plastic	5	⊕
KC D2 L20	KN D2 L20	Slow action	Metal	5	⊕

⊕ Direct (positive) opening action ⊖; safety function according to IEC/EN 60947-5-1.

⊕ Consult Customer Service for information; see contact details on inside front cover.

Ø14x5mm = Ø0.55x0.2".

General characteristics

The LOVATO ELECTRIC limit switches have been designed to satisfy requirements comprising quick installation, easy wiring, simple setup, modularity, sturdiness and constant reliability. The body cover is hinged at the bottom and removable. The innovative locking bayonet mechanism permits to remove and reposition the operating head in the required configuration with no tools. The heads have axial rotation of 45° angles. The auxiliary contact blocks are removable assuring remarkable wiring ease.

Operational characteristics

- Maximum operating rate: 3600 cycles/h
- Switching speed: 0.5...1.5m/s
- Mechanical life: >10 million cycles
- IEC conventional thermal current Ith: 10A
- UL/CSA and IEC/EN 60947-5-1 designation:
 - A600 Q300 for KB-KC types
 - A300 Q300 for KM-KN types
- IEC rated insulation voltage Ui:
 - 690VAC for KB-KC types
 - 440VAC for KM-KN types
- IEC rated impulse withstand voltage Uimp:
 - 6kV for KB-KC types
 - 4kV for KM-KN types
- Class II insulation for KB-KC only
- Contact resistance: <10mΩ
- Short-circuit backup protection: 10A gG/SC quick fuse
- Operators of aluminium-zinc alloy
- Housing:
 - KB-KC types - Self-extinguishing double-insulation polymer thermoplastic
 - KM-KN types - Aluminium-zinc alloy
- Cable entry: M20 standard supplied; PG13.5 and 1/2 NPT available (see the side note for details)
- Operating head fixing: Locking bayonet insert
- Operating force: 6N / 1.34lb
- Cable connection: Self-releasing screw terminal
- Tightening torque:
 - Switch fixing: 2.5Nm / 22.1lbin
 - Contact terminals: 0.8Nm / 7lbin
 - Body lid screw fixing: 0.8Nm / 7lbin
- Conductor section: 1 or 2 2.5mm² max / 16-14 AWG
- Ambient conditions:
 - Operating temperature: -25...+70°C
 - Storage temperature: -40...+70°C
 - Pollution degree: 3
 - IEC degree of protection: IP20 for terminals
 - IEC degree of protection: IP65 for body housing.

Certifications and compliance

Certifications obtained: EAC, CCC; UL Listed for USA and Canada (cULus - File E93601), as Auxiliary Devices - Limit switches. Compliant with standards: EN 50047, IEC/EN 60947-1, IEC/EN 60947-5-1, IEC/EN 60204-1, UL508, CSA C22.2 n° 14.

- ▶ Forward travel of snap action contacts
- ◀ Return travel of snap action contacts

□ open
■ closed

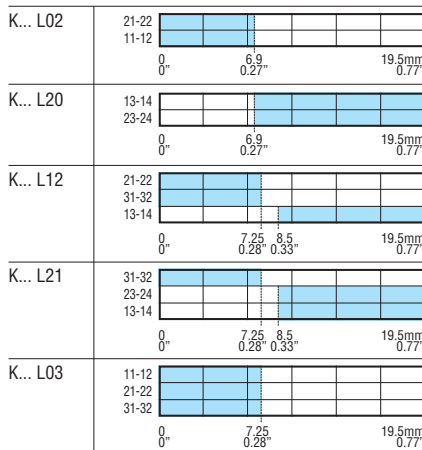
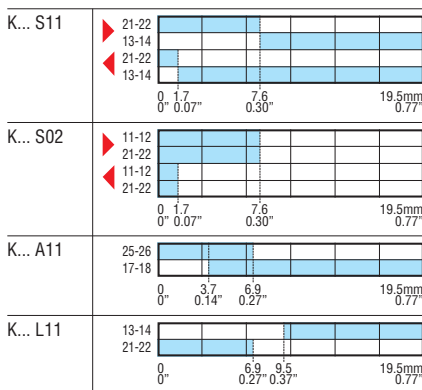

Limit, micro and foot switches

Limit switches, K series.

One bottom cable entry. Dimensions to EN 50047

Roller lever plunger



KB E1... - KB E2...
KM E1... - KM E2...

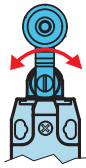

KB E3... - KM E3...

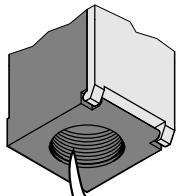

M20 CABLE ENTRY

For types with PG13.5 cable entry, add the letter P at the end of the order code while for 1/2 NPT, add N. E.g. KBE1S11P - KBE1S11N

Order code Plastic body	Metal body	Contacts	Roller material	Qty per pkg	Wt [kg]
One bottom cable entry. Dimensions to EN 50047.					
KB E1 S11	KM E1 S11	1NO+1NC	Plastic ①	5	④
KB E2 S11	KM E2 S11	Snap action ③	Metal ①	5	④
KB E3 S11	KM E3 S11		Rubber ②	5	④
KB E1 S02	KM E1 S02	2NC	Plastic ①	5	④
KB E2 S02	KM E2 S02	Snap action ③	Metal ①	5	④
KB E3 S02	KM E3 S02		Rubber	5	④
KB E1 A11	KM E1 A11	1NO+1NC	Plastic ①	5	④
KB E2 A11	KM E2 A11	Slow action make before break ⑤	Metal ①	5	④
KB E3 A11	KM E3 A11		Rubber ②	5	④
KB E1 L11	KM E1 L11	1NO+1NC	Plastic ①	5	④
KB E2 L11	KM E2 L11	Slow action ③	Metal ①	5	④
KB E3 L11	KM E3 L11		Rubber ②	5	④
KB E1 L02	KM E1 L02	2NC	Plastic ①	5	④
KB E2 L02	KM E2 L02	Slow action ③	Metal ①	5	④
KB E3 L02	KM E3 L02		Rubber ②	5	④
KB E1 L20	KM E1 L20	2NO	Plastic ①	5	④
KB E2 L20	KM E2 L20	Slow action	Metal ①	5	④
KB E3 L20	KM E3 L20		Rubber ②	5	④
KB E1 L12	KM E1 L12	1NO+2NC	Plastic ①	5	④
KB E2 L12	KM E2 L12	Slow action ③	Metal ①	5	④
KB E3 L12	KM E3 L12		Rubber ②	5	④
KB E1 L21	KM E1 L21	2NO+1NC	Plastic ①	5	④
KB E2 L21	KM E2 L21	Slow action ③	Metal ①	5	④
KB E3 L21	KM E3 L21		Rubber ②	5	④
KB E1 L03	KM E1 L03	3NC	Plastic ①	5	④
KB E2 L03	KM E2 L03	Slow action ③	Metal ①	5	④
KB E3 L03	KM E3 L03		Rubber ②	5	④

BI-DIRECTIONAL.

One bottom cable entry. Dimensions to EN 50047.

KB E1 D02	KM E1 D02	2NC ⑥ independent	Plastic ①	5	⑤
-----------	-----------	-------------------	-----------	---	---

① Ø19x5mm = Ø0.75x0.2"

② Ø50x10mm = Ø1.97"x0.39"

③ Direct (positive) opening action ⊕; safety function according to IEC/EN 60947-5-1.

④ Consult Customer Service for information; see contact details on inside front cover.

General characteristics

The LOVATO ELECTRIC limit switches have been designed to satisfy requirements comprising quick installation, easy wiring, simple setup, modularity, sturdiness and constant reliability. The body cover is hinged at the bottom and removable. The innovative locking bayonet mechanism permits to remove and reposition the operating head in the required configuration with no tools. The heads have axial rotation of 45° angles. The auxiliary contact blocks are removable assuring remarkable wiring ease.

Operational characteristics

- Maximum operating rate: 3600 cycles/h
- Switching speed: 0.5...1.5m/s
- Mechanical life: >10 million cycles
- IEC conventional thermal current Ith: 10A
- UL/CSA and IEC/EN 60947-5-1 designation:
 - A600 Q300 for KB types
 - A300 Q300 for KM types
- IEC rated insulation voltage Ui:
 - 690V for KB types
 - 440V for KM types
- IEC rated impulse withstand voltage Uimp:
 - 6kVAC for KB types
 - 4kVAC for KM types
- Class II insulation for KB only
- Contact resistance: <10mΩ
- Short-circuit backup protection: 10A gG/SC quick fuse
- Operators of aluminium-zinc alloy
- Housing:
 - KB types - Self-extinguishing double-insulation polymer thermoplastic
 - KM types - Aluminium-zinc alloy
- Cable entry: M20 standard supplied; PG13.5 and 1/2 NPT available (see the side note for details)
- Operating head fixing: Locking bayonet insert
- Operating torque: 3Ncm / 4.25ozin
- Cable connection: Self-releasing screw terminal
- Tightening torque:
 - Switch fixing: 2.5Nm / 22.1lbin
 - Contact terminals: 0.8Nm / 7lbin
 - Body lid screw fixing: 0.8Nm / 7lbin
- Conductor section: 1 or 2 2.5mm² max / 16-14 AWG
- Ambient conditions:
 - Operating temperature: -25...+70°C
 - Storage temperature: -40...+70°C
 - Pollution degree: 3
 - IEC degree of protection: IP20 for terminals
 - IEC degree of protection: IP65 for body housing.

Certifications and compliance

Certifications obtained: EAC, CCC; UL Listed for USA and Canada (cULus - File E93601), as Auxiliary Devices - Limit switches.

Compliant with standards: EN 50047, IEC/EN 60947-1, IEC/EN 60947-5-1, IEC/EN 60204-1, UL508, CSA C22.2 n° 14.

- ▶ Forward travel of snap action contacts
- ◀ Return travel of snap action contacts

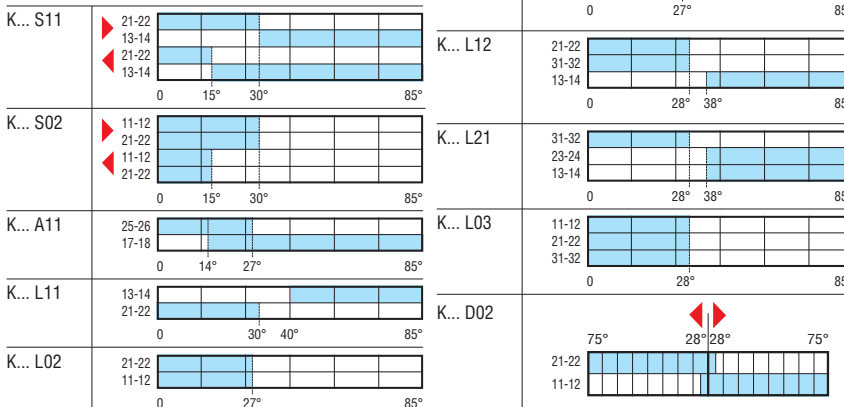

Limit, micro and foot switches

Limit switches, K series.

Two side cable entries. Dimensions compatible to EN 50047

Roller lever plunger



KC E1... - KC E2...
KN E1... - KN E2...

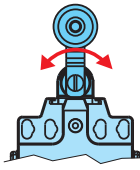

KC E3... - KN E3...

Order code Plastic body	Metal body	Contacts	Roller material	Qty per pkg	Wt
				n°	[kg]
Two side cable entries. Dimensions compatible to EN 50047.					
KC E1 S11	KN E1 S11	1NO+1NC	Plastic ①	5	④
KC E2 S11	KN E2 S11	Snap action ⑥	Metal ①	5	④
KC E3 S11	KN E3 S11		Rubber ②	5	④
KC E1 S02	KN E1 S02	2NC	Plastic ①	5	④
KC E2 S02	KN E2 S02	Snap action ⑥	Metal ①	5	④
KC E3 S02	KN E3 S02		Rubber	5	④
KC E1 A11	KN E1 A11	1NO+1NC	Plastic ①	5	④
KC E2 A11	KN E2 A11	Slow action make before break ⑤	Metal ①	5	④
KC E3 A11	KN E3 A11		Rubber ②	5	④
KC E1 L11	KN E1 L11	1NO+1NC	Plastic ①	5	④
KC E2 L11	KN E2 L11	Slow action ⑥	Metal ①	5	④
KC E3 L11	KN E3 L11		Rubber ②	5	④
KC E1 L02	KN E1 L02	2NC	Plastic ①	5	④
KC E2 L02	KN E2 L02	Slow action ⑥	Metal ①	5	④
KC E3 L02	KN E3 L02		Rubber ②	5	④
KC E1 L20	KN E1 L20	2NO	Plastic ①	5	④
KC E2 L20	KN E2 L20	Slow action	Metal ①	5	④
KC E3 L20	KN E3 L20		Rubber ②	5	④

BI-DIRECTIONAL.
Two side cable entries. Dimensions compatible to EN 50047.

Order code	Metal body	Contacts	Roller material	Qty per pkg	Wt
KC E1 D02	KN E1 D02	2NC ⑤ independent	Plastic ①	5	④

① Ø19x5mm = Ø0.75x0.2"

② Ø50x10mm = Ø1.97"x0.39"

③ Direct (positive) opening action ⊕; safety function according to IEC/EN 60947-5-1.

④ Consult Customer Service for information; see contact details on inside front cover.

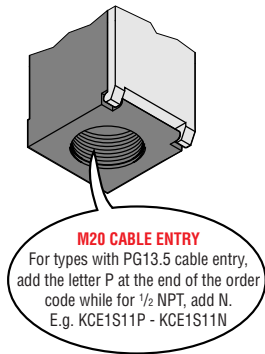

General characteristics

The LOVATO ELECTRIC limit switches have been designed to satisfy requirements comprising quick installation, easy wiring, simple setup, modularity, sturdiness and constant reliability.

The body cover is hinged at the bottom and removable. The innovative locking bayonet mechanism permits to remove and reposition the operating head in the required configuration with no tools. The heads have axial rotation of 90° angles.

The auxiliary contact blocks are removable assuring remarkable wiring ease.

Operational characteristics

- Maximum operating rate: 3600 cycles/h
- Switching speed: 0.5...1.5m/s
- Mechanical life: >10 million cycles
- IEC conventional thermal current Ith: 10A
- UL/CSA and IEC/EN 60947-5-1 designation:
 - A600 Q300 for KC types
 - A300 Q300 for KN types
- IEC rated insulation voltage Ui:
 - 690VAC for KC types
 - 440VAC for KN types
- IEC rated impulse withstand voltage Uimp:
 - 6kV for KC types
 - 4kV for KN types
- Class II insulation for KC only
- Contact resistance: <10mΩ
- Short-circuit backup protection: 10A gG/SC quick fuse
- Operators of aluminium-zinc alloy
- Housing:
 - KC types - Self-extinguishing double-insulation polymer thermoplastic
 - KN types - Aluminium-zinc alloy
- Cable entry: M20 standard supplied; PG13.5 and 1/2 NPT available (see the side note for details)
- Operating head fixing: Locking bayonet insert
- Operating torque: 3Nm/4.25ozin
- Cable connection: Self-releasing screw terminal
- Tightening torque:
 - Switch fixing: 2.5Nm / 22.1lbin
 - Contact terminals: 0.8Nm / 7lbin
 - Body lid screw fixing: 0.8Nm / 7lbin
- Conductor section: 1 or 2 2.5mm² max / 16-14 AWG
- Ambient conditions:
 - Operating temperature: -25...+70°C
 - Storage temperature: -40...+70°C
 - Pollution degree: 3
 - IEC degree of protection: IP20 for terminals
 - IEC degree of protection: IP65 for body housing.

Certifications and compliance

Certifications obtained: EAC, CCC; UL Listed for USA and Canada (cULus - File E93601), as Auxiliary Devices - Limit switches.

Compliant with standards: IEC/EN 60947-1, IEC/EN 60947-5-1, IEC/EN 60204-1, UL508, CSA C22.2 n° 14.

- ▶ Forward travel of snap action contacts
- ◀ Return travel of snap action contacts

□ open

■ closed

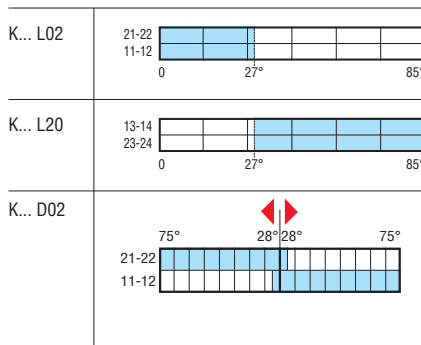
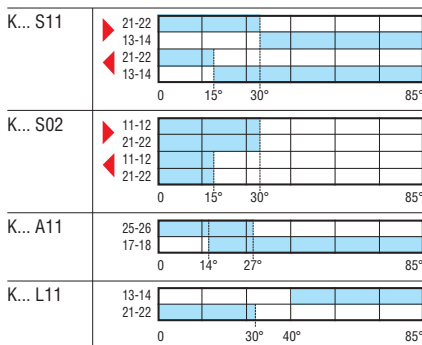

Limit, micro and foot switches

Limit switches, K series.

One bottom cable entry. Dimensions to EN 50047

Adjustable roller lever



KB F... - KM F...

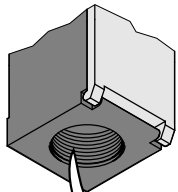
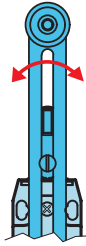

M20 CABLE ENTRY

For types with PG13.5 cable entry, add the letter P at the end of the order code while for 1/2 NPT, add N. E.g. KBF1S11P - KBF1S11N

Order code	Plastic body	Metal body	Contacts	Roller material	Qty per pkg	Wt [kg]
One bottom cable entry. Dimensions to EN 50047.						
KB F1 S11	KB F1 S11	1NO+1NC	Plastic ①	5	⑤	
KB F2 S11	KB F2 S11	Snap action ④	Metal ①	5	⑤	
KB F3 S11	KB F3 S11		Rubber ②	5	⑤	
KB F4 S11	KB F4 S11		Rubber ③	5	⑤	
KB F1 S02	KB F1 S02		2NC	Plastic ①	5	⑤
KB F2 S02	KB F2 S02	Snap action ④	Metal ①	5	⑤	
KB F3 S02	KB F3 S02		Rubber ②	5	⑤	
KB F4 S02	KB F4 S02		Rubber ③	5	⑤	
KB F1 A11	KB F1 A11	1NO+1NC	Plastic ①	5	⑤	
KB F2 A11	KB F2 A11	Slow action make before break ④	Metal ①	5	⑤	
KB F3 A11	KB F3 A11		Rubber ②	5	⑤	
KB F4 A11	KB F4 A11		Rubber ③	5	⑤	
KB F1 L11	KB F1 L11		1NO+1NC	Plastic ①	5	⑤
KB F2 L11	KB F2 L11	Slow action ④	Metal ①	5	⑤	
KB F3 L11	KB F3 L11		Rubber ②	5	⑤	
KB F4 L11	KB F4 L11		Rubber ③	5	⑤	
KB F1 L02	KB F1 L02	2NC	Plastic ①	5	⑤	
KB F2 L02	KB F2 L02	Slow action ④	Metal ①	5	⑤	
KB F3 L02	KB F3 L02		Rubber ②	5	⑤	
KB F4 L02	KB F4 L02		Rubber ③	5	⑤	
KB F1 L20	KB F1 L20	2NO	Plastic ①	5	⑤	
KB F2 L20	KB F2 L20	Slow action	Metal ①	5	⑤	
KB F3 L20	KB F3 L20		Rubber ②	5	⑤	
KB F4 L20	KB F4 L20		Rubber ③	5	⑤	
KB F1 L12	KB F1 L12	1NO+2NC	Plastic ①	5	⑤	
KB F2 L12	KB F2 L12	Slow action ④	Metal ①	5	⑤	
KB F3 L12	KB F3 L12		Rubber ②	5	⑤	
KB F4 L12	KB F4 L12		Rubber ③	5	⑤	
KB F1 L21	KB F1 L21		2NO+1NC	Plastic ①	5	⑤
KB F2 L21	KB F2 L21	Slow action ④	Metal ①	5	⑤	
KB F3 L21	KB F3 L21		Rubber ②	5	⑤	
KB F4 L21	KB F4 L21		Rubber ③	5	⑤	
KB F1 L03	KB F1 L03	3NC	Plastic ①	5	⑤	
KB F2 L03	KB F2 L03	Slow action ④	Metal ①	5	⑤	
KB F3 L03	KB F3 L03		Rubber ②	5	⑤	
KB F4 L03	KB F4 L03		Rubber ③	5	⑤	

BI-DIRECTIONAL.

One bottom cable entry. Dimensions to EN 50047.

KB F1 D02	KB F1 D02	2NC ④ independent	Plastic ①	5	⑤
-----------	-----------	-------------------	-----------	---	---

① Ø19x5mm = Ø0.75x0.2"

② Ø50x10mm = Ø1.97x0.34"

③ Ø50x10mm (Ø1.97x0.35") with offset alignment.

④ Direct (positive) opening action ☺; safety function according to IEC/EN 60947-5-1.

⑤ Consult Customer Service for information; see contact details on inside front cover.

▶ Forward travel of snap action contacts ☐ open
 ◀ Return travel of snap action contacts ■ closed

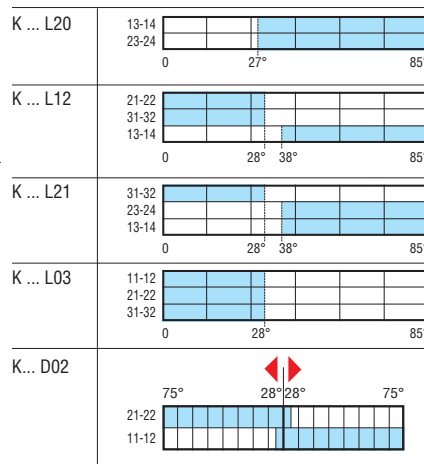
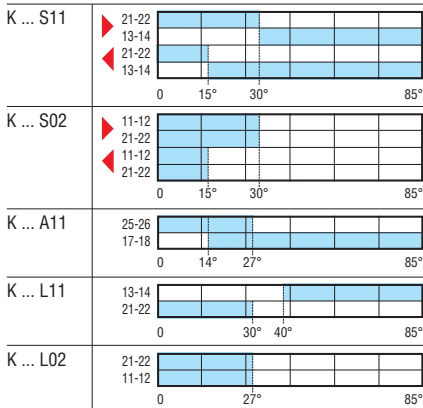

General characteristics

The LOVATO ELECTRIC limit switches have been designed to satisfy requirements comprising quick installation, easy wiring, simple setup, modularity, sturdiness and constant reliability. The body cover is hinged at the bottom and removable. The innovative locking bayonet mechanism permits to remove and reposition the operating head in the required configuration with no tools. The heads have axial rotation of 180° angles. The auxiliary contact blocks are removable assuring remarkable wiring ease.

Operational characteristics

- Maximum operating rate: 3600 cycles/h
- Switching speed: 0.5...1.5m/s
- Mechanical life: >10 million cycles
- IEC conventional thermal current Ith: 10A
- UL/CSA and IEC/EN 60947-5-1 designation:
 - A600 Q300 for KB types
 - A300 Q300 for KM types
- IEC rated insulation voltage Ui:
 - 690V for KB types
 - 440V for KM types
- IEC rated impulse withstand voltage Uimp:
 - 6kVAC for KB types
 - 4kVAC for KM types
- Class II insulation for KB only
- Contact resistance: <10mΩ
- Short-circuit backup protection: 10A gG/SC quick fuse
- Operators of aluminium-zinc alloy
- Housing:
 - KB types - Self-extinguishing double-insulation polymer thermoplastic
 - KM types - Aluminium-zinc alloy
- Cable entry: M20 standard supplied; PG13.5 and 1/2 NPT available (see the side note for details)
- Operating head fixing: Locking bayonet insert
- Operating force: 3Ncm/4.25ozin
- Cable connection: Self-releasing screw terminal
- Tightening torque:
 - Switch fixing: 2.5Nm / 22.1lbin
 - Contact terminals: 0.8Nm / 7lbin
 - Body lid screw fixing: 0.8Nm / 7lbin
- Conductor section: 1 or 2 2.5mm² max / 16-14 AWG
- Ambient conditions:
 - Operating temperature: -25...+70°C
 - Storage temperature: -40...+70°C
 - Pollution degree: 3
 - IEC degree of protection: IP20 for terminals
 - IEC degree of protection: IP65 for body housing.

Certifications and compliance

Certifications obtained: EAC, CCC; UL Listed for USA and Canada (cULus - File E93601), as Auxiliary Devices - Limit switches.

Compliant with standards: EN 50047, IEC/EN 60947-1, IEC/EN 60947-5-1, IEC/EN 60204-1, UL508, CSA C22.2 n° 14.

Limit, micro and foot switches

Limit switches, K series.

Two side cable entries. Dimensions compatible to EN 50047

Adjustable roller lever

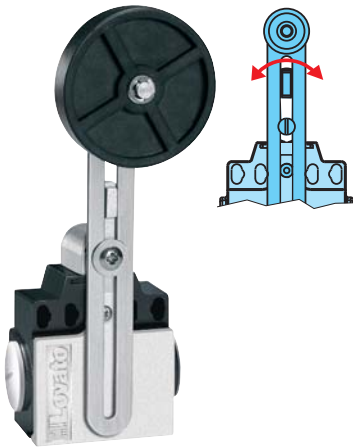

KC F... - KN F...

Order code	Plastic body	Metal body	Contacts	Roller material	Qty per pkg	Wt
Two side cable entries. Dimensions compatible to EN 50047.						
KC F1 S11	KN F1 S11		1NO+1NC	Plastic ①	5	④
KC F2 S11	KN F2 S11		Snap action ②	Metal ①	5	④
KC F3 S11	KN F3 S11			Rubber ②	5	④
KC F4 S11	KN F4 S11			Rubber off. align. ②	5	④
KC F1 S02	KN F1 S02			2NC	Plastic ①	5
KC F2 S02	KN F2 S02		Snap action ②	Metal ①	5	④
KC F3 S02	KN F3 S02			Rubber ②	5	④
KC F4 S02	KN F4 S02			Rubber off. align. ②	5	④
KC F1 A11	KN F1 A11		1NO+1NC	Plastic ①	5	④
KC F2 A11	KN F2 A11		Slow action make before break ③	Metal ①	5	④
KC F3 A11	KN F3 A11			Rubber ②	5	④
KC F4 A11	KN F4 A11			Rubber off. align. ②	5	④
KC F1 L11	KN F1 L11			1NO+1NC	Plastic ①	5
KC F2 L11	KN F2 L11		Slow action ③	Metal ①	5	④
KC F3 L11	KN F3 L11			Rubber ②	5	④
KC F4 L11	KN F4 L11			Rubber off. align. ②	5	④
KC F1 L02	KN F1 L02		2NC	Plastic ①	5	④
KC F2 L02	KN F2 L02		Slow action ③	Metal ①	5	④
KC F3 L02	KN F3 L02			Rubber ②	5	④
KC F4 L02	KN F4 L02			Rubber off. align. ②	5	④
KC F1 L20	KN F1 L20		2NO	Plastic ①	5	④
KC F2 L20	KN F2 L20		Slow action	Metal ①	5	④
KC F3 L20	KN F3 L20			Rubber ②	5	④
KC F4 L20	KN F4 L20			Rubber off. align. ②	5	④

- ① Ø19x5mm = Ø0.75x0.2".
 - ② Ø50x10mm = Ø1.97x0.34".
 - ③ Direct (positive) opening action ⊕; safety function according to IEC/EN 60947-5-1.
 - ④ Consult Customer Service for information; see contact details on inside front cover.
- off. align. = offset alignment.

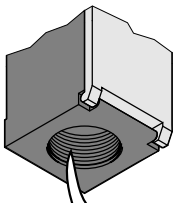

M20 CABLE ENTRY

For types with PG13.5 cable entry, add the letter P at the end of the order code while for 1/2 NPT, add N. E.g. KCF1S11P - KCF1S11N

General characteristics

The LOVATO ELECTRIC limit switches have been designed to satisfy requirements comprising quick installation, easy wiring, simple setup, modularity, sturdiness and constant reliability. The body cover is hinged at the bottom and removable. The innovative locking bayonet mechanism permits to remove and reposition the operating head in the required configuration with no tools. The heads have axial rotation of 180° angles. The auxiliary contact blocks are removable assuring remarkable wiring ease.

Operational characteristics

- Maximum operating rate: 3600 cycles/h
- Switching speed: 0.5...1.5m/s
- Mechanical life: >10 million cycles
- IEC conventional thermal current Ith: 10A
- UL/CSA and IEC/EN 60947-5-1 designation:
 - A600 Q300 for KC types
 - A300 Q300 for KN types
- IEC rated insulation voltage Ui:
 - 690VAC for KC types
 - 440VAC for KN types
- IEC rated impulse withstand voltage Uimp:
 - 6kV for KC types
 - 4kV for KN types
- Class II insulation for KC only
- Contact resistance: <10mΩ
- Short-circuit backup protection: 10A gG/SC quick fuse
- Operators of aluminium-zinc alloy
- Housing:
 - KC types - Self-extinguishing double-insulation polymer thermoplastic
 - KN types - Aluminium-zinc alloy
- Cable entry: M20 standard supplied; PG13.5 and 1/2 NPT available (see the side note for details)
- Operating head fixing: Locking bayonet insert
- Operating force: 3Ncm/4.25ozin
- Cable connection: Self-releasing screw terminal
- Tightening torque:
 - Switch fixing: 2.5Nm / 22.1lbin
 - Contact terminals: 0.8Nm / 7lbin
 - Body lid screw fixing: 0.8Nm / 7lbin
- Conductor section: 1 or 2 2.5mm² max / 16-14 AWG
- Ambient conditions:
 - Operating temperature: -25...+70°C
 - Storage temperature: -40...+70°C
 - Pollution degree: 3
 - IEC degree of protection: IP20 for terminals
 - IEC degree of protection: IP65 for body housing.

Certifications and compliance

Certifications obtained: EAC, CCC; UL Listed for USA and Canada (cULus - File E93601), as Auxiliary Devices - Limit switches. Compliant with standards: EN 50047, IEC/EN 60947-1, IEC/EN 60947-5-1, IEC/EN 60204-1, UL508, CSA C22.2 n° 14.

- ▶ Forward travel of snap action contacts
- ◀ Return travel of snap action contacts

□ open
■ closed

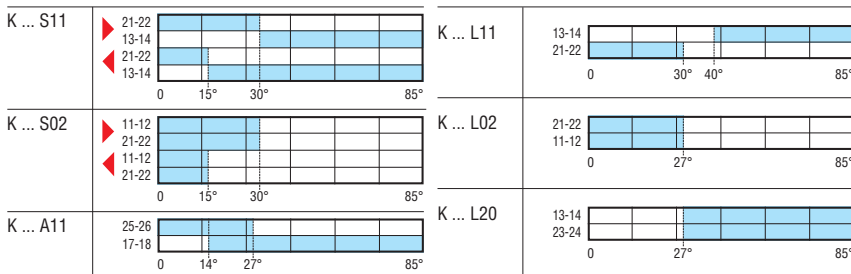

Limit, micro and foot switches

Limit switches, K series. One bottom cable entry. Dimensions to EN 50047
Two side cable entries. Dimensions compatible to EN 50047

Ceramic rod lever



KB H... - KM H...

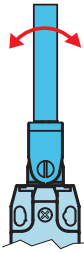

KC H... - KN H...

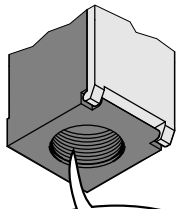

M20 CABLE ENTRY

For types with PG13.5 cable entry, add the letter P at the end of the order code while for 1/2 NPT, add N. E.g. KBH1S11P - KBH1S11N

Order code Plastic body	Metal body	Contacts	Rod material	Qty per pkg	Wt
				n°	[kg]
One bottom cable entry. Dimensions to EN 50047.					
KB H1 S11	KM H1 S11	1NO+1NC Snap action Ⓢ	Ceramic	5	Ⓢ
KB H1 S02	KM H1 S02	2NC Snap action Ⓢ	Ceramic	5	Ⓢ
KB H1 A11	KM H1 A11	1NO+1NC Slow action make before break Ⓢ	Ceramic	5	Ⓢ
KB H1 L11	KM H1 L11	1NO+1NC Slow action Ⓢ	Ceramic	5	Ⓢ
KB H1 L02	KM H1 L02	2NC Slow action Ⓢ	Ceramic	5	Ⓢ
KB H1 L20	KM H1 L20	2NO Slow action	Ceramic	5	Ⓢ
KB H1 L12	KM H1 L12	1NO+2NC Slow action Ⓢ	Ceramic	5	Ⓢ
KB H1 L21	KM H1 L21	2NO+1NC Slow action Ⓢ	Ceramic	5	Ⓢ
KB H1 L03	KM H1 L03	3NC Slow action Ⓢ	Ceramic	5	Ⓢ

Order code Plastic body	Metal body	Contacts	Rod material	Qty per pkg	Wt
				n°	[kg]
Two side cable entries. Dimensions compatible to EN 50047.					
KC H1 S11	KN H1 S11	1NO+1NC Snap action Ⓢ	Ceramic	5	Ⓢ
KC H1 S02	KN H1 S02	2NC Snap action Ⓢ	Ceramic	5	Ⓢ
KC H1 A11	KN H1 A11	1NO+1NC Slow action make before break Ⓢ	Ceramic	5	Ⓢ
KC H1 L11	KN H1 L11	1NO+1NC Slow action Ⓢ	Ceramic	5	Ⓢ
KC H1 L02	KN H1 L02	2NC Slow action Ⓢ	Ceramic	5	Ⓢ
KC H1 L20	KN H1 L20	2NO Slow action	Ceramic	5	Ⓢ

Ⓢ Direct (positive) opening action Ⓢ safety function according to IEC/EN 60947-5-1.

Ⓢ Consult Customer Service for information; see contact details on inside front cover.

General characteristics

The LOVATO ELECTRIC limit switches have been designed to satisfy requirements comprising quick installation, easy wiring, simple setup, modularity, sturdiness and constant reliability. The body cover is hinged at the bottom and removable. The innovative locking bayonet mechanism permits to remove and reposition the operating head in the required configuration with no tools. The heads have axial rotation of 45° angles. The auxiliary contact blocks are removable assuring remarkable wiring ease.

Operational characteristics

- Maximum operating rate: 3600 cycles/h
- Switching speed: 0.5...1.5m/s
- Mechanical life: >10 million cycles
- IEC conventional thermal current Ith: 10A
- UL/CSA and IEC/EN 60947-5-1 designation:
 - A600 Q300 for KB-KC types
 - A300 Q300 for KM-KN types
- IEC rated insulation voltage Ui:
 - 690VAC for KB-KC types
 - 440VAC for KM-KN types
- IEC rated impulse withstand voltage Uimp:
 - 6kV for KB-KC types
 - 4kV for KM-KN types
- Class II insulation for KB-KC only
- Contact resistance: <10mΩ
- Short-circuit backup protection: 10A gG/SC quick fuse
- Operators of aluminium-zinc alloy
- Housing:
 - KB-KC types - Self-extinguishing double-insulation polymer thermoplastic
 - KM-KN types - Aluminium-zinc alloy
- Cable entry: M20 standard supplied; PG13.5 and 1/2 NPT available (see the side note for details)
- Operating head fixing: Locking bayonet insert
- Operating torque: 3Ncm/4.25ozin
- Cable connection: Self-releasing screw terminal
- Tightening torque:
 - Switch fixing: 2.5Nm / 22.1lbin
 - Contact terminals: 0.8Nm / 7lbin
 - Body lid screw fixing: 0.8Nm / 7lbin
- Conductor section: 1 or 2 2.5mm² max / 16-14 AWG
- Ambient conditions:
 - Operating temperature: -25...+70°C
 - Storage temperature: -40...+70°C
 - Pollution degree: 3
 - IEC degree of protection: IP20 for terminals
 - IEC degree of protection: IP65 for body housing.

Certifications and compliance

Certifications obtained: EAC, CCC; UL Listed for USA and Canada (cULus - File E93601), as Auxiliary Devices - Limit switches. Compliant with standards: EN 50047, IEC/EN 60947-1, IEC/EN 60947-5-1, IEC/EN 60204-1, UL508, CSA C22.2 n° 14.

- ▶ Forward travel of snap action contacts
- ◀ Return travel of snap action contacts

□ open
■ closed

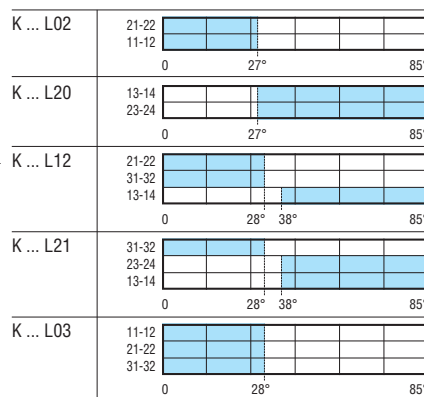
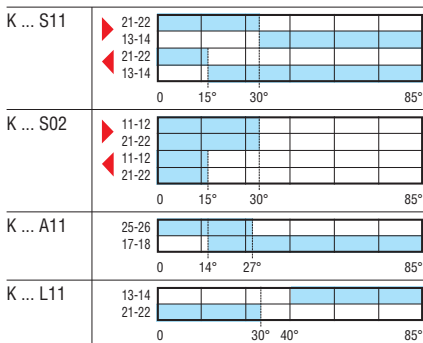

Limit, micro and foot switches

Limit switches, K series. One bottom cable entry. Dimensions to EN 50047
Two side cable entries. Dimensions compatible to EN 50047

Adjustable rod lever



KB L... - KM L...



KC L... - KN L...

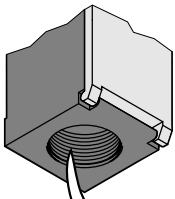

M20 CABLE ENTRY

For types with PG13.5 cable entry, add the letter P at the end of the order code while for 1/2 NPT, add N. E.g. KBL1S11P - KBL1S11N

Order code	Metal body	Contacts	Rod material	Qty per pkg	Wt
Plastic body				n°	[kg]

One bottom cable entry. Dimensions to EN 50047.

KB L1 S11	KM L1 S11	1NO+1NC	Plastic	5	⊕
KB L2 S11	KM L2 S11	Snap actionⓈ	Steel	5	⊕
KB L1 S02	KM L1 S02	2NC	Plastic	5	⊕
KB L2 S02	KM L2 S02	Snap actionⓈ	Steel	5	⊕
KB L1 A11	KM L1 A11	1NO+1NC	Plastic	5	⊕
KB L2 A11	KM L2 A11	Slow action make before breakⓈ	Steel	5	⊕
KB L1 L11	KM L1 L11	1NO+1NC	Plastic	5	⊕
KB L2 L11	KM L2 L11	Slow actionⓈ	Steel	5	⊕
KB L1 L02	KM L1 L02	2NC	Plastic	5	⊕
KB L2 L02	KM L2 L02	Slow actionⓈ	Steel	5	⊕
KB L1 L20	KM L1 L20	2NO	Plastic	5	⊕
KB L2 L20	KM L2 L20	Slow action	Steel	5	⊕
KB L1 L12	KM L1 L12	1NO+2NC	Plastic	5	⊕
KB L2 L12	KM L2 L12	Slow actionⓈ	Steel	5	⊕
KB L1 L21	KM L1 L21	2NO+1NC	Plastic	5	⊕
KB L2 L21	KM L2 L21	Slow actionⓈ	Steel	5	⊕
KB L1 L03	KM L1 L03	3NC	Plastic	5	⊕
KB L2 L03	KM L2 L03	Slow actionⓈ	Steel	5	⊕

Two side cable entries. Dimensions compatible to EN 50047.

KC L1 S11	KN L1 S11	1NO+1NC	Plastic	5	⊕
KC L2 S11	KN L2 S11	Snap actionⓈ	Steel	5	⊕
KC L1 S02	KN L1 S02	2NC	Plastic	5	⊕
KC L2 S02	KN L2 S02	Snap actionⓈ	Steel	5	⊕
KC L1 A11	KN L1 A11	1NO+1NC	Plastic	5	⊕
KC L2 A11	KN L2 A11	Slow action make before breakⓈ	Steel	5	⊕
KC L1 L11	KN L1 L11	1NO+1NC	Plastic	5	⊕
KC L2 L11	KN L2 L11	Slow actionⓈ	Steel	5	⊕
KC L1 L02	KN L1 L02	2NC	Plastic	5	⊕
KC L2 L02	KN L2 L02	Slow actionⓈ	Steel	5	⊕
KC L1 L20	KN L1 L20	2NO	Plastic	5	⊕
KC L2 L20	KN L2 L20	Slow action	Steel	5	⊕

BI-DIRECTIONAL.

One bottom cable entry. Dimensions to EN 50047.

KB L1 D02	KM L1 D02	2NC ① independent	Plastic ①	5	⊕
KB L2 D02	KM L2 D02	2NC ① independent	Steel ①	5	⊕

① Direct (positive) opening action ⊕; safety function according to IEC/EN 60947-5-1.

⊕ Consult Customer Service for information; see contact details on inside front cover.

General characteristics

The LOVATO ELECTRIC limit switches have been designed to satisfy requirements comprising quick installation, easy wiring, simple setup, modularity, sturdiness and constant reliability. The body cover is hinged at the bottom and removable. The innovative locking bayonet mechanism permits to remove and reposition the operating head in the required configuration with no tools. The heads have axial rotation of 90° angles (180° for KC and KN types). The auxiliary contact blocks are removable assuring remarkable wiring ease.

Operational characteristics

- Maximum operating rate: 3600 cycles/h
- Switching speed: 0.5...1.5m/s
- Mechanical life: >10 million cycles
- IEC conventional thermal current Ith: 10A
- UL/CSA and IEC/EN 60947-5-1 designation:
 - A600 Q300 for KB-KC types
 - A300 Q300 for KM-KN types
- IEC rated insulation voltage Ui:
 - 690VAC for KB-KC types
 - 440VAC for KM-KN types
- IEC rated impulse withstand voltage Uimp:
 - 6kV for KB-KC types
 - 4kV for KM-KN types
- Class II insulation for KB-KC only
- Contact resistance: <10mΩ
- Short-circuit backup protection: 10A gG/SC quick fuse
- Operators of aluminium-zinc alloy
- Housing:
 - KB-KC types - Self-extinguishing double-insulation polymer thermoplastic
 - KM-KN types - Aluminium-zinc alloy
- Cable entry: M20 standard supplied; PG13.5 and 1/2 NPT available (see the side note for details)
- Operating head fixing: Locking bayonet insert
- Operating force: 3Ncm/4.25ozin
- Cable connection: Self-releasing screw terminal
- Tightening torque:
 - Switch fixing: 2.5Nm / 22.1lbin
 - Contact terminals: 0.8Nm / 7lbin
 - Body lid screw fixing: 0.8Nm / 7lbin
- Conductor section: 1 or 2 2.5mm² max / 16-14 AWG
- Ambient conditions:
 - Operating temperature: -25...+70°C
 - Storage temperature: -40...+70°C
 - Pollution degree: 3
 - IEC degree of protection: IP20 for terminals
 - IEC degree of protection: IP65 for body housing.

Certifications and compliance

Certifications obtained: EAC, CCC; UL Listed for USA and Canada (cULus - File E93601), as Auxiliary Devices - Limit switches. Compliant with standards: EN 50047, IEC/EN 60947-1, IEC/EN 60947-5-1, IEC/EN 60204-1, UL508, CSA C22.2 n° 14.

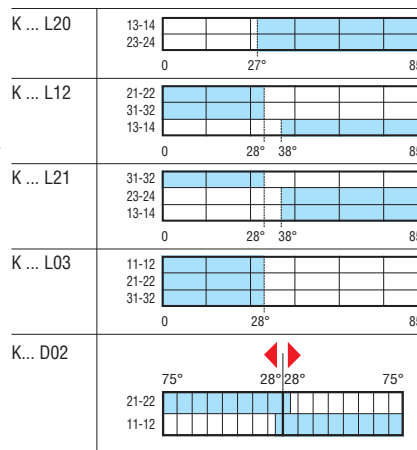
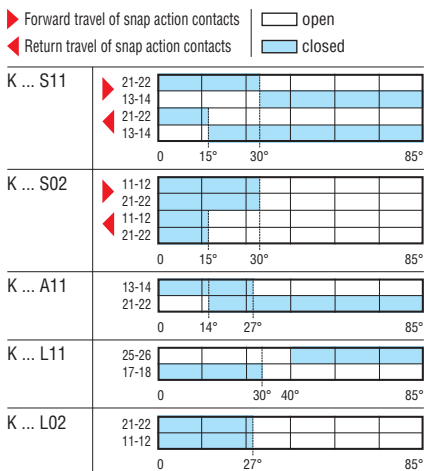

Limit, micro and foot switches

Limit switches, K series. One bottom cable entry. Dimensions to EN 50047
Two side cable entries. Dimensions compatible to EN 50047

Wobble stick, omnidirectional

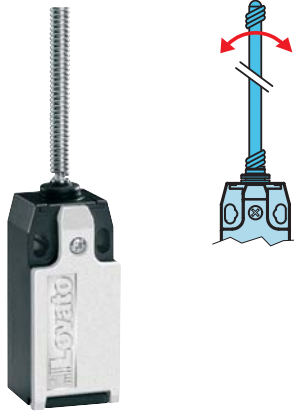

KB M1... - KM M1...



KC M2... - KN M2...

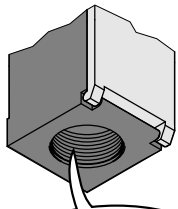

M20 CABLE ENTRY

For types with PG13.5 cable entry, add the letter P at the end of the order code while for 1/2 NPT, add N. E.g. KBM1S11P - KBM1S11N

Order code	Plastic body	Metal body	Contacts	Rod material	Qty per pkg	Wt
					n°	[kg]
One bottom cable entry. Dimensions to EN 50047.						
KB M1 S11	KM M1 S11		1NO+1NC	Flexible	5	①
KB M2 S11	KM M2 S11		Snap action	Semirigid	5	①
KB M1 S02	KM M1 S02		2NC	Flexible	5	①
KB M2 S02	KM M2 S02		Snap action	Semirigid	5	①
KB M1 A11	KM M1 A11		1NO+1NC	Flexible	5	①
KB M2 A11	KM M2 A11		Slow action make before break	Semirigid	5	①
KB M1 L11	KM M1 L11		1NO+1NC	Flexible	5	①
KB M2 L11	KM M2 L11		Slow action	Semirigid	5	①
KB M1 L02	KM M1 L02		2NC	Flexible	5	①
KB M2 L02	KM M2 L02		Slow action	Semirigid	5	①
KB M1 L20	KM M1 L20		2NO	Flexible	5	①
KB M2 L20	KM M2 L20		Slow action	Semirigid	5	①
KB M1 L12	KM M1 L12		1NO+2NC	Flexible	5	①
KB M2 L12	KM M2 L12		Slow action	Semirigid	5	①
KB M1 L21	KM M1 L21		2NO+1NC	Flexible	5	①
KB M2 L21	KM M2 L21		Slow action	Semirigid	5	①
KB M1 L03	KM M1 L03		3NC	Flexible	5	①
KB M2 L03	KM M2 L03		Slow action	Semirigid	5	①
Two side cable entries. Dimensions compatible to EN 50047.						
KC M1 S11	KN M1 S11		1NO+1NC	Flexible	5	①
KC M2 S11	KN M2 S11		Snap action	Semirigid	5	①
KC M1 S02	KN M1 S02		2NC	Flexible	5	①
KC M2 S02	KN M2 S02		Snap action	Semirigid	5	①
KC M1 A11	KN M1 A11		1NO+1NC	Flexible	5	①
KC M2 A11	KN M2 A11		Slow action make before break	Semirigid	5	①
KC M1 L11	KN M1 L11		1NO+1NC	Flexible	5	①
KC M2 L11	KN M2 L11		Slow action	Semirigid	5	①
KC M1 L02	KN M1 L02		2NC	Flexible	5	①
KC M2 L02	KN M2 L02		Slow action	Semirigid	5	①
KC M1 L20	KN M1 L20		2NO	Flexible	5	①
KC M2 L20	KN M2 L20		Slow action	Semirigid	5	①

① Consult Customer Service for information; see contact details on inside front cover.

General characteristics

The LOVATO ELECTRIC limit switches have been designed to satisfy requirements comprising quick installation, easy wiring, simple setup, modularity, sturdiness and constant reliability. The body cover is hinged at the bottom and removable. The innovative locking bayonet mechanism permits to remove and reposition the operating head in the required configuration with no tools. The auxiliary contact blocks are removable assuring remarkable wiring ease.

Operational characteristics

- Maximum operating rate: 3600 cycles/h
- Switching speed: 0.5...1.5m/s
- Mechanical life: >10 million cycles
- IEC conventional thermal current Ith: 10A
- UL/CSA and IEC/EN 60947-5-1 designation:
 - A600 Q300 for KB-KC types
 - A300 Q300 for KM-KN types
- IEC rated insulation voltage Ui:
 - 690VAC for KB-KC types
 - 440VAC for KM-KN types
- IEC rated impulse withstand voltage Uimp:
 - 6kV for KB-KC types
 - 4kV for KM-KN types
- Class II insulation for KB-KC only
- Contact resistance: <10mΩ
- Short-circuit backup protection: 10A gG/SC quick fuse
- Operators of aluminium-zinc alloy
- Housing:
 - KB-KC types - Self-extinguishing double-insulation polymer thermoplastic
 - KM-KN types - Aluminium-zinc alloy
- Cable entry: M20 standard supplied; PG13.5 and 1/2 NPT available (see the side note for details)
- Operating head fixing: Locking bayonet insert
- Operating torque: 1Ncm/1.42ozin
- Cable connection: Self-releasing screw terminal
- Tightening torque:
 - Switch fixing: 2.5Nm / 22.1lbin
 - Contact terminals: 0.8Nm / 7lbin
 - Body lid screw fixing: 0.8Nm / 7lbin
- Conductor section: 1 or 2 2.5mm² max / 16-14 AWG
- Ambient conditions:
 - Operating temperature: -25...+70°C
 - Storage temperature: -40...+70°C
 - Pollution degree: 3
 - IEC degree of protection: IP20 for terminals
 - IEC degree of protection: IP65 for body housing.

Certifications and compliance

Certifications obtained: EAC, CCC; UL Listed for USA and Canada (cULus - File E93601), as Auxiliary Devices - Limit switches. Compliant with standards: EN 50047, IEC/EN 60947-1, IEC/EN 60947-5-1, IEC/EN 60204-1, UL508, CSA C22.2 n° 14.

▶ Forward travel of snap action contacts □ open
 ◀ Return travel of snap action contacts ■ closed

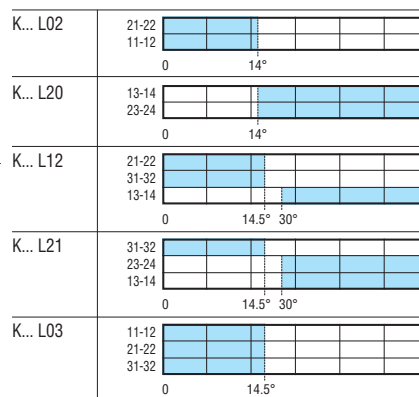
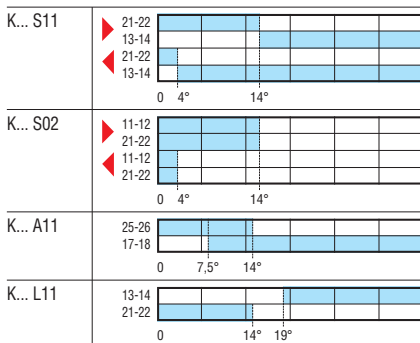

Limit, micro and foot switches

Limit switches, K series. One bottom cable entry. Dimensions to EN 50047
Two side cable entries. Dimensions compatible to EN 50047

Hinge operating



KB P... - KM P...



KC P... - KN P...

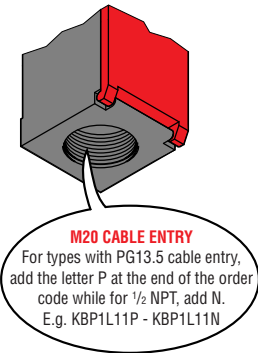

Order code	Plastic body	Metal body	Contacts	Shaft features	Qty per pkg	Wt
					n°	[kg]

One bottom cable entry. Dimensions to EN 50047.

KB P1 L11	KM P1 L11	1NO+1NC Slow action Ⓢ	Short cylinder	5	Ⓢ
KB P2 L11	KM P2 L11	1NO+1NC Slow action Ⓢ	Long solid	5	Ⓢ
KB P3 L11	KM P3 L11	1NO+1NC Slow action Ⓢ	Long solid w/ reduction	5	Ⓢ
KB P1 L02	KM P1 L02	2NC Slow action Ⓢ	Short cylinder	5	Ⓢ
KB P2 L02	KM P2 L02	2NC Slow action Ⓢ	Long solid	5	Ⓢ
KB P3 L02	KM P3 L02	2NC Slow action Ⓢ	Long solid w/ reduction	5	Ⓢ
KB P1 L12	KM P1 L12	1NO+2NC Slow action Ⓢ	Short cylinder	5	Ⓢ
KB P2 L12	KM P2 L12	1NO+2NC Slow action Ⓢ	Long solid	5	Ⓢ
KB P3 L12	KM P3 L12	1NO+2NC Slow action Ⓢ	Long solid w/ reduction	5	Ⓢ
KB P1 L21	KM P1 L21	2NO+1NC Slow action Ⓢ	Short cylinder	5	Ⓢ
KB P2 L21	KM P2 L21	2NO+1NC Slow action Ⓢ	Long solid	5	Ⓢ
KB P3 L21	KM P3 L21	2NO+1NC Slow action Ⓢ	Long solid w/ reduction	5	Ⓢ
KB P1 L03	KM P1 L03	3NC Slow action Ⓢ	Short cylinder	5	Ⓢ
KB P2 L03	KM P2 L03	3NC Slow action Ⓢ	Long solid	5	Ⓢ
KB P3 L03	KM P3 L03	3NC Slow action Ⓢ	Long solid w/ reduction	5	Ⓢ

Two side cable entries. Dimensions compatible to EN 50047.

KC P1 L11	KN P1 L11	1NO+1NC Slow action Ⓢ	Short cylinder	5	Ⓢ
KC P2 L02	KN P2 L02	1NO+1NC Slow action Ⓢ	Long solid	5	Ⓢ
KC P3 L11	KN P3 L11	1NO+1NC Slow action Ⓢ	Long solid w/ reduction	5	Ⓢ
KC P1 L02	KN P1 L02	2NC Slow action Ⓢ	Short cylinder	5	Ⓢ
KC P2 L02	KN P2 L02	2NC Slow action Ⓢ	Long solid	5	Ⓢ
KC P3 L02	KN P3 L02	2NC Slow action Ⓢ	Long solid w/ reduction	5	Ⓢ

- Ⓢ Direct (positive) opening action ⊖; safety function according to IEC/EN 60947-5-1.
- Ⓢ Consult Customer Service for information; see contact details on inside front cover.

General characteristics

The LOVATO ELECTRIC limit switches have been designed to satisfy requirements comprising quick installation, easy wiring, simple setup, modularity, sturdiness and constant reliability. The body cover is hinged at the bottom and removable. The innovative locking bayonet mechanism permits to remove and reposition the operating head in the required configuration with no tools. The auxiliary contact blocks are removable assuring remarkable wiring ease.

Operational characteristics

- Maximum operating rate: 3600 cycles/h
- Switching speed: 0.5...1.5m/s
- Mechanical life: 100,000 cycles
- B10d: 100,000 cycles
- IEC conventional thermal current Ith: 10A
- UL/CSA and IEC/EN 60947-5-1 designation:
 - A600 Q300 for KB-KC types
 - A300 Q300 for KM-KN types
- IEC rated insulation voltage Ui:
 - 690VAC for KB-KC types
 - 440VAC for KM-KN types
- IEC rated impulse withstand voltage Uimp:
 - 6kV for KB-KC types
 - 4kV for KM-KN types
- Class II insulation for KB-KC only
- Contact resistance: <10mΩ
- Short-circuit backup protection: 10A gG/SC quick fuse
- Operators of aluminium-zinc alloy
- Housing:
 - KB-KC types - Self-extinguishing double-insulation polymer thermoplastic
 - KM-KN types - Aluminium-zinc alloy
- Cable entry: M20 standard supplied; PG13.5 and 1/2 NPT available (see the side note for details)
- Operating head fixing: Locking bayonet insert
- Operating torque: 15Ncm/21.2ozin
- Cable connection: Self-releasing screw terminal
- Tightening torque:
 - Switch fixing: 2.5Nm / 22.1lbin
 - Contact terminals: 0.8Nm / 7lbin
 - Body lid screw fixing: 0.8Nm / 7lbin
- Conductor section: 1 or 2 2.5mm² max / 16-14 AWG
- Ambient conditions:
 - Operating temperature: -25...+70°C
 - Storage temperature: -40...+70°C
 - Pollution degree: 3
 - IEC degree of protection: IP20 for terminals
 - IEC degree of protection: IP65 for body housing.

Certifications and compliance

Certifications obtained: EAC, CCC; UL Listed for USA and Canada (cULus - File E93601), as Auxiliary Devices - Limit switches. Compliant with standards: EN 50047, IEC/EN 60947-1, IEC/EN 60947-5-1, IEC/EN 60204-1, UL508, CSA C22.2 n° 14.

□ open
 ■ closed

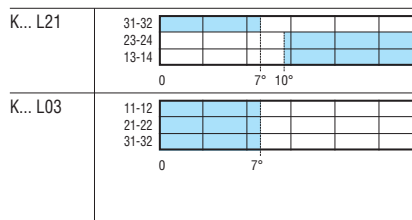
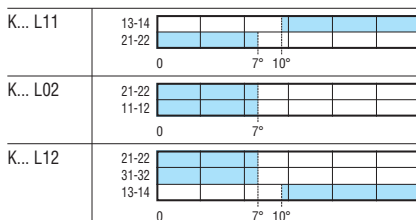

Limit, micro and foot switches

Limit switches, K series. One bottom cable entry. Dimensions to EN 50047
Two side cable entries. Dimensions compatible to EN 50047

Slotted lever

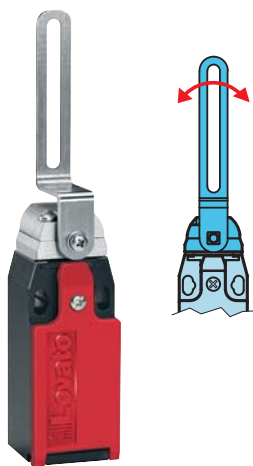

KB Q... - KM Q...

Order code	Plastic body	Metal body	Contacts	Qty per pkg	Wt [kg]
One bottom cable entry. Dimensions to EN 50047.					
KB Q1 L11	KM Q1 L11		1NO+1NC Slow action ①	5	②
KB Q1 L02	KM Q1 L02		2NC Slow action ①	5	②
KB Q1 L12	KM Q1 L12		1NO+2NC Slow action ①	5	②
KB Q1 L21	KM Q1 L21		2NO+1NC Slow action ①	5	②
KB Q1 L03	KM Q1 L03		3NC Slow action ①	5	②
Two side cable entries. Dimensions compatible to EN 50047.					
KC Q1 L11	KN Q1 L11		1NO+1NC Slow action ①	5	②
KC Q1 L02	KN Q1 L02		2NC Slow action ①	5	②

① Direct (positive) opening action \ominus ; safety function according to IEC/EN 60947-5-1.
② Consult Customer Service for information; see contact details on inside front cover.



KC Q... - KN Q...

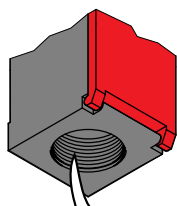

M20 CABLE ENTRY

For types with PG13.5 cable entry, add the letter P at the end of the order code while for 1/2 NPT, add N.
E.g. KBQ1L11P - KBQ1L11N

□ open
■ closed

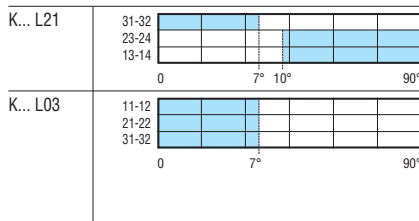
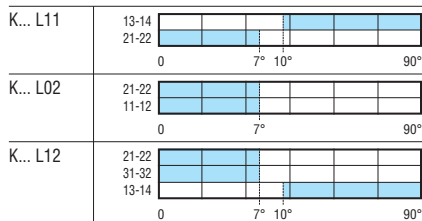

General characteristics

The LOVATO ELECTRIC limit switches have been designed to satisfy requirements comprising quick installation, easy wiring, simple setup, modularity, sturdiness and constant reliability. The body cover is hinged at the bottom and removable. The innovative locking bayonet mechanism permits to remove and reposition the operating head in the required configuration with no tools. The auxiliary contact blocks are removable assuring remarkable wiring ease.

Operational characteristics

- Maximum operating rate: 3600 cycles/h
- Switching speed: 0.5...1.5m/s
- Mechanical life: 100,000 cycles
- B10d: 100,000 cycles
- IEC conventional thermal current Ith: 10A
- UL/CSA and IEC/EN 60947-5-1 designation:
 - A600 Q300 for KB-KC types
 - A300 Q300 for KM-KN types
- IEC rated insulation voltage Ui:
 - 690VAC for KB-KC types
 - 440VAC for KM-KN types
- IEC rated impulse withstand voltage Uimp:
 - 6kV for KB-KC types
 - 4kV for KM-KN types
- Class II insulation for KB-KC only
- Contact resistance: <10mΩ
- Short-circuit backup protection: 10A gG/SC quick fuse
- Operators of aluminium-zinc alloy
- Housing:
 - KB-KC types - Self-extinguishing double-insulation polymer thermoplastic
 - KM-KN types - Aluminium-zinc alloy
- Cable entry: M20 standard supplied; PG13.5 and 1/2 NPT available (see the side note for details)
- Operating head fixing: Locking bayonet insert
- Operating torque: 15Ncm/21.2ozin
- Cable connection: Self-releasing screw terminal
- Tightening torque:
 - Switch fixing: 2.5Nm / 22.1lbin
 - Contact terminals: 0.8Nm / 7lbin
 - Body lid screw fixing: 0.8Nm / 7lbin
- Conductor section: 1 or 2 2.5mm² max / 16-14 AWG
- Ambient conditions:
 - Operating temperature: -25...+70°C
 - Storage temperature: -40...+70°C
 - Pollution degree: 3
 - IEC degree of protection: IP20 for terminals
 - IEC degree of protection: IP65 for body housing.

Certifications and compliance

Certifications obtained: EAC, CCC; UL Listed for USA and Canada (cULus - File E93601), as Auxiliary Devices - Limit switches. Compliant with standards: EN 50047, IEC/EN 60947-1, IEC/EN 60947-5-1, IEC/EN 60204-1, UL508, CSA C22.2 n° 14.

Limit, micro and foot switches

Limit switches, K series. One bottom cable entry. Dimensions to EN 50047
Two side cable entries. Dimensions compatible to EN 50047

Key operated



KB N...

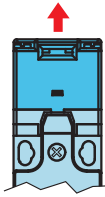

KC N...

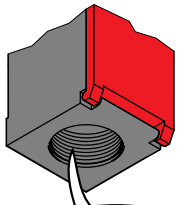

M20 CABLE ENTRY

For types with PG13.5 cable entry, add the letter P at the end of the order code while for 1/2 NPT, add N. E.g. KBN1L11P - KBN1L11N

□ open
 ■ closed

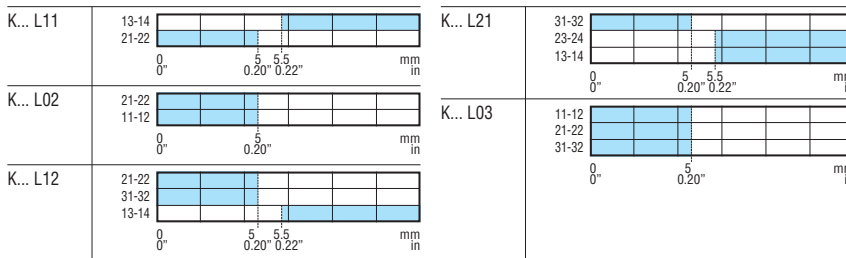

Order code Plastic body	Contacts	Key shape [Ⓜ]	Qty per pkg	Wt
			n°	[kg]

One bottom cable entry. Dimensions to EN 50047.

KB N1 L11	1NO+1NC	Straight	5	0.092
KB N2 L11	Slow action [Ⓛ]	Angled	5	0.092
KB N3 L11		Straight "T"	5	0.092
KB N4 L11		Angled "T"	5	0.092
KB N1 L02	2NC	Straight	5	0.092
KB N2 L02	Slow action [Ⓛ]	Angled	5	0.092
KB N3 L02		Straight "T"	5	0.092
KB N4 L02		Angled "T"	5	0.092
KB N1 L12	1NO+2NC	Straight	5	0.096
KB N2 L12	Slow action [Ⓛ]	Angled	5	0.096
KB N3 L12		Straight "T"	5	0.096
KB N4 L12		Angled "T"	5	0.096
KB N1 L21	2NO+1NC	Straight	5	0.096
KB N2 L21	Slow action [Ⓛ]	Angled	5	0.096
KB N3 L21		Straight "T"	5	0.096
KB N4 L21		Angled "T"	5	0.096
KB N1 L03	3NC	Straight	5	0.096
KB N2 L03	Slow action [Ⓛ]	Angled	5	0.096
KB N3 L03		Straight "T"	5	0.096
KB N4 L03		Angled "T"	5	0.096

Two side cable entries. Dimensions compatible to EN 50047.

KC N1 L11	1NO+1NC	Straight	5	0.107
KC N2 L11	Slow action [Ⓛ]	Angled	5	0.107
KC N3 L11		Straight "T"	5	0.107
KC N4 L11		Angled "T"	5	0.107
KC N1 L02	2NC	Straight	5	0.107
KC N2 L02	Slow action [Ⓛ]	Angled	5	0.107
KC N3 L02		Straight "T"	5	0.107
KC N4 L02		Angled "T"	5	0.107

- Ⓛ Direct (positive) opening action ⊖; safety function according to IEC/EN 60947-5-1.
- Ⓜ The key is standard supplied.

General characteristics

The LOVATO ELECTRIC limit switches have been designed to satisfy requirements comprising quick installation, easy wiring, simple setup, modularity, sturdiness and constant reliability. The body cover is hinged at the bottom and removable. The heads have axial rotation in any of 4 positions at 90° angles. The auxiliary contact blocks are removable assuring remarkable wiring ease.

Operational characteristics

- Maximum operating rate: 3600 cycles/h
- Switching speed: 0.5...1.5m/s
- Mechanical life: 100,000 cycles
- B10d: 100,000 cycles
- IEC conventional thermal current Ith: 10A
- UL/CSA and IEC/EN 60947-5-1 designation: A600 Q600
- IEC rated insulation voltage Ui: 690V
- IEC rated impulse withstand voltage Uimp: 6kV
- Class II insulation
- Contact resistance: <10mΩ
- Short-circuit backup protection: 10A gG/SC quick fuse
- Housing and operators in self-extinguishing double-insulation polymer thermoplastic
- Cable entry: M20 standard supplied; PG13.5 and 1/2 NPT available (see the side note for details)
- Operating head fixing: Locking bayonet insert
- Operating force: 8N/1.8lb
- Cable connection: Self-releasing screw terminal
- Tightening torque:
 - Switch fixing: 2.5Nm / 22.1lbin
 - Contact terminals: 0.8Nm / 7lbin
 - Body lid screw fixing: 0.8Nm / 7lbin
- Conductor section: 1 or 2 2.5mm² max / 16-14 AWG
- Ambient conditions:
 - Operating temperature: -25...+70°C
 - Storage temperature: -40...+70°C
 - Pollution degree: 3
 - IEC degree of protection: IP20 for terminals
 - IEC degree of protection: IP65 for body housing.

Certifications and compliance

Certifications obtained: EAC, CCC; UL Listed for USA and Canada (cULus - File E93601), as Auxiliary Devices - Limit switches. Compliant with standards: EN 50047, IEC/EN 60947-1, IEC/EN 60947-5-1, IEC/EN 60204-1, UL508, CSA C22.2 n° 14.

Accessories and spare parts for key operated switches



Order code	Description	Qty per pkg	Wt
		n°	[kg]
K X N1	Straight key	5	0.013
K X N2	Angled key	5	0.013
K X N3	Straight "T" key	5	0.012
K X N4	Angled "T" key	5	0.012
K X N5	Toggle key	5	0.019

Limit, micro and foot switches

Limit switches, K series.

Accessories and spare parts for KB - KC - KM and KN type limit switches

Contact blocks



K X B...

Order code	Contacts	Qty per pkg	Wt
		n°	[kg]
KX B S11	1NO+1NC Snap action ①②	10	0.021
KX B S02	2NC Snap action ①②	10	0.021
KX B A11	1NO+1NC Slow action make before break ①②	10	0.021
KX B L11	1NO+1NC Slow action ②	10	0.021
KX B L02	2NC Slow action ②	10	0.021
KX B L20	2NO Slow action	10	0.021
KX B L12	1NO+2NC Slow action ②③	10	0.026
KX B L21	2NO+1NC Slow action ②③	10	0.026
KX B L03	3NC Slow action ②③	10	0.026

- ① Not suitable for key operated KBN / KCN, hinged operating KBP / KCP / KMP / KNP and slotted lever KBQ / KCQ / KMQ / KNQ types.
- ② Direct (positive) opening action \ominus ; safety function according to IEC/EN 60947-5-1.
- ③ Not suitable for KC and KN types, KG and KR foot switches.

Body complete with contact block

9



KX CB... - KX CM...



KX CC... - KX CN...

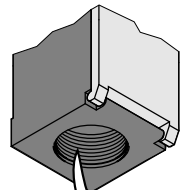

M20 CABLE ENTRY

For types with PG13.5 cable entry, add the letter P at the end of the order code while for 1/2 NPT, add N. E.g. KXCCL11P - KXCCL11N

Order code Plastic body	Metal body	Contacts	Qty per pkg	Wt
			n°	[kg]

One bottom cable entry. Dimensions to EN 50047.

KX CB S11	KX CM S11	1NO+1NC Snap action ①②	10	④
KX CB S02	KX CM S02	2NC Snap action ①②	10	④
KX CB A11	KX CM A11	1NO+1NC Slow action make before break ①②	10	④
KX CB L11	KX CM L11	1NO+1NC Slow action ②	10	④
KX CB L02	KX CM L02	2NC Slow action ②	10	④
KX CB L20	KX CM L20	2NO Slow action	10	④
KX CB L12	KX CM L12	1NO+2NC Slow action ②③	10	④
KX CB L21	KX CM L21	2NO+1NC Slow action ②③	10	④
KX CB L03	KX CM L03	3NC Slow action ②③	10	④

Two side cable entries. Dimensions compatible to EN 50047.

KX CC S11	KX CN S11	1NO+1NC Snap action ①②	10	④
KX CC S02	KX CN S02	2NC Snap action ①②	10	④
KX CC A11	KX CN A11	1NO+1NC Slow action make before break ①②	10	④
KX CC L11	KX CN L11	1NO+1NC Slow action ②	10	④
KX CC L02	KX CN L02	2NC Slow action ②	10	④
KX CC L20	KX CN L20	2NO Slow action	10	④

- ① Not suitable for key operated KBN / KCN, hinged operating KBP / KCP / KMP / KNP and slotted lever KBQ / KCQ / KMQ / KNQ types.
- ② Direct (positive) opening action \ominus ; safety function according to IEC/EN 60947-5-1.
- ③ Not suitable for KC and KN types.
- ④ Consult Customer Service for information; see contact details on inside front cover.

General characteristics

The KXB contact blocks can be used with the K series of limit switches. Combinations of 2 contacts with slow or snap action and, for KB and KM types only, 3 slow action contacts are available. The NC contacts have direct opening operation, a specific safety principle. The particular four-point contacts warrant high conductivity in any sort of application. The removal of the contacts from the limit switch body provides remarkable wiring ease and reduces installation time as well. The KX C... bodies, complete with auxiliary contacts, can be used as spare parts for the K series limit switches or coupled with the KX A... operating heads, to obtain complete limit switches in the required configurations. The body cover is hinged at the bottom and removable to have the best access. Each body includes the innovative locking bayonet mechanism of the operating head. Plastic and metal types are available.

Operational characteristics

- Mechanical life: >10 million cycles
- IEC conventional thermal current Ith: 10A
- conductivity: 10mA 5V
- UL/CSA and IEC/EN 60947-5-1 designation:
 - A600 Q300 for KX CB-KX CC types
 - A300 Q300 for KX CM-KX CN types
- IEC rated insulation voltage Ui:
 - 690VAC for KX CB-KX CC types
 - 440VAC for KX CM-KX CN types
- IEC rated impulse withstand voltage Uimp:
 - 6kV for KX CB-KX CC types
 - 4kV for KX CM-KX CN types
- Class II insulation for KX CB-KX CC only
- Contact resistance: <10mΩ
- Short-circuit backup protection: 10A gG/SC quick fuse
- Housing:
 - KX CB-KX CC types - Self-extinguishing double-insulation polymer thermoplastic
 - KX CM-KX CN types - Aluminium-zinc alloy
- Cable entry: M20 standard supplied; PG13.5 and 1/2 NPT available (see the side note for details)
- Operating head fixing: Locking bayonet insert
- Cable connection: Self-releasing screw terminal
- Tightening torque:
 - Switch fixing: 2.5Nm / 22.1lbin
 - Contact terminals: 0.8Nm / 7lbin
 - Body lid screw fixing: 0.8Nm / 7lbin
- Conductor section: 1 or 2 2.5mm² max / 16-14 AWG
- Ambient conditions:
 - Operating temperature: -25...+70°C
 - Storage temperature: -40...+70°C
 - Pollution degree: 3
 - IEC degree of protection: IP20 for terminals
 - IEC degree of protection: IP65 for body housing.

Certifications and compliance

Certifications obtained: EAC for all; UL Listed for US and Canada (File E93601), as Auxiliary Devices for USA and Canada (cURus - File E93601) as component - Auxiliary devices for contact blocks only; products having this type of marking are intended for use as components of complete workshop-assembled equipment. Comply with standards: EN50047, IEC/EN 60947-1, IEC/EN60947-5-1, IEC/EN 60204-1, UL508, CSA C22.2 n° 14.

- ▶ Forward travel of snap action contacts
- ◀ Return travel of snap action contacts

□ open
■ closed

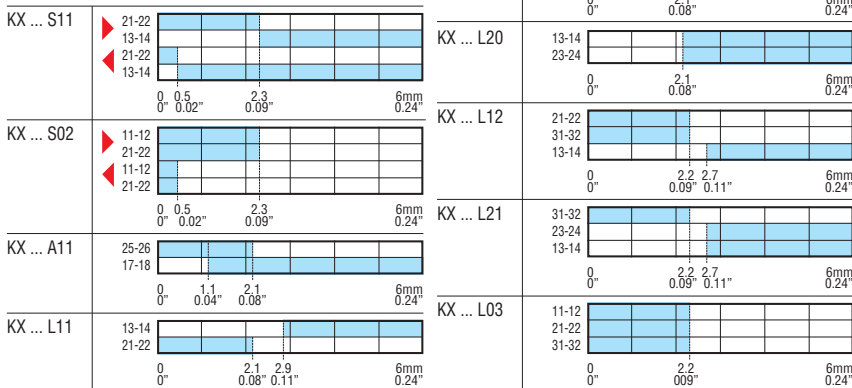

Limit, micro and foot switches

Limit switches, K series.

Accessories and spare parts for KB, KC, KM and KN type limit switches

Operating heads



Order code	Description	Qty per pkg	Wt
		n°	[kg]
KX A A1	Top push rod plunger	5	0.013
KX A B1	Plastic top roller push plunger	5	0.020
KX A B2	Metal top roller push plunger	5	0.020
KX A C1	Plastic roller centre push lever	5	0.020
KX A C2	Metal roller centre push lever	5	0.020
KX A D1	Plastic roller side push lever	5	0.020
KX A D2	Metal roller side push lever	5	0.023
KX A E1	Plastic roller lever plunger	5	0.039
KX A E2	Metal roller lever plunger	5	0.048
KX A E3	Rubber Ø50x10mm [Ⓜ] roller lever plunger	5	0.055
KX A F1	Adjustable plastic roller lever Ø19x5mm [Ⓜ]	5	0.055
KX A F2	Adjustable metal roller lever Ø19x5mm [Ⓜ]	5	0.065
KX A F3	Adjustable rubber Ø50x10mm [Ⓜ] roller lever	5	0.065
KX A F4	Adjustable offset rubber Ø50x10mm [Ⓜ] roller lever	5	0.081
KX A H1	Ceramic rod lever	5	0.056
KX A L1	Adjustable plastic rod lever	5	0.043
KX A L2	Adjustable stainless steel rod lever	5	0.050
KX A M1	Flexible wobble stick	5	0.032
KX A M2	Semirigid wobble stick	5	0.025

[Ⓜ] Ø19x5mm = Ø0.75"x0.2".

[Ⓜ] Ø50x10mm = Ø1.97"x0.39".

General characteristics

The KX A... operating heads can be used as spare parts for the K series limit switches or coupled with the KX C... bodies to obtain complete limit switches in the required configurations.

The heads are made of metal and warrant sturdiness and operating reliability in all conditions.

The shape of the coupling section with the body of the K series switches permits to orient the head in any 45° angle position while the initial lever and rod position can be adjusted 360° at 15° angle positions.

The head fixing to the body is achieved by the innovative locking bayonet mechanism so there is no need of tools. Tightening torque for eventual operating head actuator fixing is 0.8Nm/7lbin.

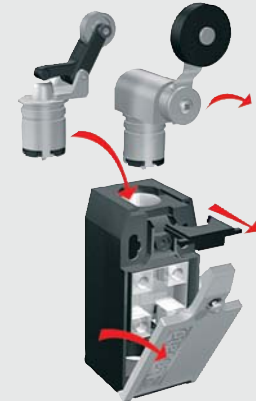

Cable glands and cable conduit



Order code	Description	Qty per pkg	Wt
		n°	[kg]
KX P01	M20 cable gland	50	0.009
KX P02	PG13.5 cable gland	50	0.009
KX P03	M20 rubber cable conduit	50	0.004

General characteristics

The cable glands are in plastic with either M20 or PG13.5 thread and provide to keep the cable in place and maintain the proper IP protection of the limit switch after installation.

Operational characteristics for cable gland

- Material: Self-extinguishing polyamide
- IEC degree of protection: IP68
- Gland seal with cable diameter: 6...12mm/0.24...0.47".

Certifications and compliance

Certifications obtained: EAC.
Compliant with standards: EN 50262, UL508.



KP A1... KP A2...



KP B1... KP B2...



KP B3... KP B4...



KP B5... KP B6...



KP B7... KP B8...



KP E1... KP E2...



KP F1... KP L2...



KP M2 S11

Order code	Contacts 1NO+1NC	Head material	Cable length ⊕	Qty per pkg	Wt
			m	n°	[kg]

TOP PUSH ROD PLUNGER.

KP A1 S11	Snap action	Metal	2	1	0.286
KP A1 L11	Slow action	Metal	2	1	0.286
KP A2 S11	Snap action	Metal	2	1	0.302
KP A2 L11	Slow action	Metal	2	1	0.302

TOP ROLLER PUSH PLUNGER.

KP B1 S11	Snap action	Plastic	2	1	0.290
KP B1 L11	Slow action	Plastic	2	1	0.290
KP B2 S11	Snap action	Metal	2	1	0.290
KP B2 L11	Slow action	Metal	2	1	0.290
KP B3 S11	Snap action	Plastic	2	1	0.288
KP B3 L11	Slow action	Plastic	2	1	0.288
KP B4 S11	Snap action	Metal	2	1	0.296
KP B4 L11	Slow action	Metal	2	1	0.296

M12 HEAD TOP ROLLER PUSH PLUNGER.

KP B5 S11	Snap action	Plastic	2	1	0.308
KP B5 L11	Slow action	Plastic	2	1	0.308
KP B6 S11	Snap action	Metal	2	1	0.310
KP B6 L11	Slow action	Metal	2	1	0.310
KP B7 S11	Snap action	Plastic	2	1	0.310
KP B7 L11	Slow action	Plastic	2	1	0.310
KP B8 S11	Snap action	Metal	2	1	0.310
KP B8 L11	Slow action	Metal	2	1	0.310

ROLLER LEVER PLUNGER.

KP E1 S11	Snap action	Plastic	2	1	0.336
KP E1 L11	Slow action	Plastic	2	1	0.336
KP E2 S11	Snap action	Metal	2	1	0.336
KP E2 L11	Slow action	Metal	2	1	0.336

ADJUSTABLE ROLLER LEVER.

KP F1 S11	Snap action	Plastic	2	1	0.344
KP F1 L11	Slow action	Plastic	2	1	0.344

ADJUSTABLE ROD LEVER.

KP L2 S11	Snap action	Metal	2	1	0.342
KP L2 L11	Slow action	Metal	2	1	0.342

OMNIDIRECTIONAL WOBBLE STICK.

KP M2 S11	Snap action	Metal	2	1	0.298
-----------	-------------	-------	---	---	-------

- ⊕ Direct (positive) opening action ⇨; safety function according to IEC/EN 60947-5-1.
- ⊖ For prewired switches with 1m long cable only, add suffix 010 at the end of the order code.
Example: KP A1 S11 010 for prewired switch, top push metal rod plunger, with 1NO+1NC snap action contacts and 1m long cable.
- ⊕ M12 head fixing.
- ⊕ Roller operation perpendicular to switch body.

Operational characteristics

- 2 meters long cable ⊕ (5 core, each 0.75mm²/18 AWG)
- Maximum operating rate: 3600 cycles/h
- Mechanical life: >10 million cycles
- IEC conventional thermal current Ith: 5A
- conductivity: 10mA 5V
- UL/CSA and IEC/EN 60947-5-1 designation: B300 R300
- IEC rated insulation voltage Ui: 400VAC
- IEC rated impulse withstand voltage Uimp: 4kV
- Class I insulation
- Contact resistance: <25mΩ
- Body housing: aluminium - zinc alloy
- Operating force/torque:
 - KP A types: 15N/3.4lb
 - KP B types: 10N/2.2lb
 - KP E, KP F and KP L types: 0.08Nm/0.7lbin
 - KP M types: 0.1Nm/0.9lbin
- Tightening torque for switch fixing: 2.5Nm/22.1lbin
- Ambient conditions:
 - Operating temperature: -25...+70°C
 - Storage temperature: -40...+70°C
 - Pollution degree: 3
 - IEC degree of protection: IP67 for body housing.

Certifications and compliance

Certifications obtained: EAC, UL Listed for USA and Canada (cULus - File E93601), as Auxiliary Devices - Limit switches.
Compliant with standards: IEC/EN 60947-1, IEC/EN 60947-5-1, UL508, CSA C22.2 n° 14.

- ▶ Forward travel of snap action contacts | open
- ◀ Return travel of snap action contacts | closed

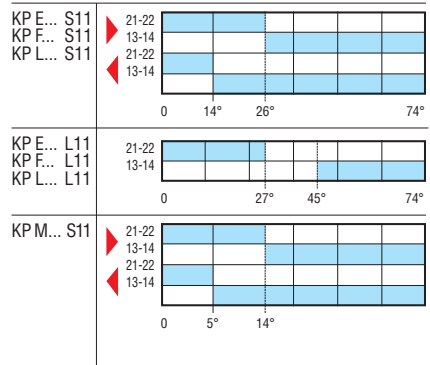
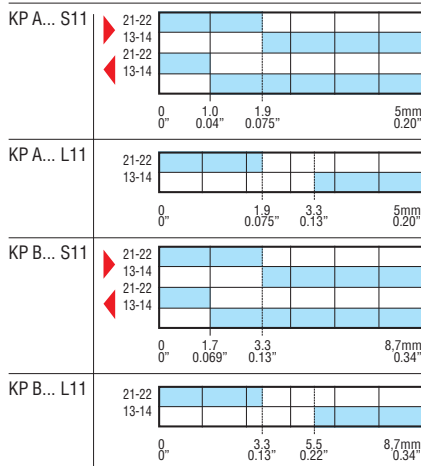

Top push rod plunger



TS1... - TL1...



TS2... - TL2...

Order code	Contacts	Plunger material	Qty per pkg	Wt
			n°	[kg]
Without reset button.				
TS1 01 10	1NO+1NC Snap action	Steel	1	0.120
TL1 01 10	1NO+1NC Ⓢ Slow action	Steel	1	0.120
With reset button on front.				
TS2 01 10	1NO+1NC Snap action	Steel	1	0.130
TL2 01 10	1NO+1NC Ⓢ Slow action	Steel	1	0.130

Ⓢ Direct (positive) opening action ⊖; safety function according to IEC/EN 60947-5-1.

Type	▶ Forward travel of snap action contacts	□ open
	◀ Return travel of snap action contacts	■ closed
TS1 01... TS2 01...	▶ 21-22 13-14 ◀ 21-22 13-14	
TL1 01... TL2 01...	▶ 21-22 13-14	
TS1 05... TS2 05...	▶ 21-22 13-14 ◀ 21-22 13-14	
TL1 05... TL2 05...	▶ 21-22 13-14	

General characteristics

The TS-TL series limit switches are designed and manufactured according to European standards EN 50041 for dimensions.

The insulated housing of the limit switch is made of self-extinguishing thermoplastic giving excellent mechanical stability and is suitable, as a result, for assembly on machinery or installations in the general-purpose industrial field as well as saline environments (for example close by the sea).

The housing sturdiness allows mounting of limit switches in heavy duty applications.

The double-insulated housing of the limit switch warrants and protects internal circuits against shocks or impacts and in industrial environments, against accidental ingress of tools and accidental contact.

The contacts are dimensioned to ensure self cleaning of the silver-alloy contact surfaces. Contacts (NC) of the TL series have direct (positive) opening action to prevent sticking or welding.

Operational characteristics

- Maximum operating rate: 1200 cycles/h
- Switching speed: 0.5...1.5m/s
- Mechanical life: >10 million cycles (100,000 cycles only for reset button versions)
- IEC utilisation category:
 - DC13 duty: 1.5A 24V
 - AC15 duty: 6A 250V
- IEC conventional thermal current Ith: 6A
- IEC rated insulation voltage Ui: 250VAC
- Contact resistance: <10mΩ
- Short-circuit backup protection: 10A gG/SC quick fuse
- Cable connection: Self-releasing screw terminal
- Operating force: 6N/1.35lb (TS...01 and TL...01)
- Operating force: 3Nm/4.25ozin (TS...05 and TL...05)
- TS...05 and TL...05 have axial rotation in any of 4 positions (90°)
- TS...05 and TL...05 have lever inclination, 360° adjustment
- Housing cable entry: PG13.5
- Tightening torque:
 - Switch fixing: 2.5Nm / 22.1lbin
 - Contact terminals: 0.8Nm / 7lbin
 - Body lid screw fixing: 0.8Nm / 7lbin
- Conductor section: 1 or 2 2.5mm² max / 16-14 AWG
- Ambient conditions:
 - Operating temperature: -25...+70°C
 - Storage temperature: -40...+70°C
 - Pollution degree: 3
 - IEC degree of protection: IP66

Certifications and compliance

Certifications obtained: EAC, UL Listed for USA and Canada (cULus - File E93601), as Auxiliary Devices - Limit switches.

Compliant with standards: IEC/EN 60947-1, IEC/EN 60947-5-1, IEC/EN 60204-1, EN 81-1, EN 50041, UL508, CSA C22.2 n° 14.

Roller lever



TS1... - TL1...



TS2... - TL2...

Order code	Contacts	Roller material	Qty per pkg	Wt
			n°	[kg]
Without reset button.				
TS1 05 20 AⓈ	1NO+1NC Snap action	Plastic Ø20x5	1	0.120
TS1 05 21 A		Metal Ø20x5	1	0.125
TS1 05 24 AⓈ		Rubber Ø50x10	1	0.135
TL1 05 20 AⓈ	1NO+1NC Ⓢ Slow action	Plastic Ø20x5	1	0.120
TL1 05 21 A		Metal Ø20x5	1	0.125
TL1 05 24 AⓈ		Rubber Ø50x10	1	0.135
With reset button.				
TS2 05 20 AⓈ	1NO+1NC Snap action	Plastic Ø20x5	1	0.130
TS2 05 21 AS		Metal Ø20x5	1	0.135
TS2 05 24 AⓈ		Rubber Ø50x10	1	0.145
TL2 05 20 AⓈ	1NO+1NC Ⓢ Slow action	Plastic Ø20x5	1	0.130
TL2 05 21 AS		Metal Ø20x5	1	0.135
TL2 05 24 AⓈ		Rubber Ø50x10	1	0.145

Ⓢ Direct (positive) opening action ⊖; safety function according to IEC/EN 60947-5-1.

Ⓢ Roller lever plunger limit switches with 30x5mm plastic roller are available and can be ordered substituting the number 20 with 23 in the above-given order codes.

Ⓢ Roller lever plunger limit switches with 35x15mm rubber roller are available and can be ordered substituting the number 24 with 22 in the above-given order codes.

Ø20x5mm = Ø0.79x0.2".

Ø50x10mm = Ø1.97x0.39".

Ø30x5mm = Ø1.81x0.2".

Ø35x15mm = Ø1.38x0.59".

Wobble stick, omnidirectional



TS1... - TL1...

Order code	Contacts	Rod material	Qty per pkg	Wt
			n°	[kg]
Without reset button.				
TS1 09 92	1NO+1NC Snap action	Flexible	1	0.115
TL1 09 92	1NO+1NC Slow action	Flexible	1	0.115

Type	▶ Forward travel of snap action contacts	◀ Return travel of snap action contacts	□ open	■ closed
TS1 09...	21-22 13-14	21-22 13-14		0 36°
TL1 09...	21-22 13-14			0 36°
TL2 10...	21-22 13-14			0 [mm (in)] 4.2 (0.17")

General characteristics

The TS-TL series limit switches are designed and manufactured according to European standards EN 50041 for dimensions.

The insulated housing of the limit switch is made of self-extinguishing thermoplastic giving excellent mechanical stability and is suitable, as a result, for assembly on machinery or installations in the general-purpose industrial field as well as saline environments (for example close by the sea).

The housing sturdiness allows mounting of limit switches in heavy duty applications.

The double-insulated housing of the limit switch warrants and protects internal circuits against shocks or impacts and in industrial environments, against accidental ingress of tools and accidental contact.

The contacts are dimensioned to ensure self cleaning of the silver-alloy contact surfaces. Contacts (NC) of the TL series have direct (positive) opening action to prevent sticking or welding.

Operational characteristics

- Maximum operating rate: 1200 cycles/h
- Switching speed: 0.5...1.5m/s
- Mechanical life: >10 million cycles
- IEC utilisation category:
 - DC13 duty: 1.5A 24V
 - AC15 duty: 6A 250V
- IEC conventional thermal current Ith: 6A
- IEC rated insulation voltage Ui: 250VAC
- Contact resistance: <10mΩ
- Short-circuit backup protection: 10A gG/SC quick fuse
- Operating torque: 1Ncm/1.42ozin (TS1 09... and TL1 09...)
- Operating force: 8N/1.8lb (TL2 10...)
- TL2 10... has axial rotation in any of 4 positions (90°)
- TL2 10... has vertical or sideways key withdrawal
- Housing cable entry: PG13.5
- Cable connection: Self-releasing screw terminal
- Tightening torque:
 - Switch fixing: 2.5Nm / 22.1lbin
 - Contact terminals: 0.8Nm / 7lbin
 - Body lid screw fixing: 0.8Nm / 7lbin
- Conductor section: 1 or 2 2.5mm² max / 16-14 AWG
- Ambient conditions:
 - Operating temperature: -25...+70°C
 - Storage temperature: -40...+70°C
 - Pollution degree: 3
 - IEC degree of protection: IP66.

Certifications and compliance

Certifications obtained: EAC, UL Listed for USA and Canada (cULus - File E93601) as Auxiliary Devices - Limit switches.

Compliant with standards: IEC/EN 60947-1, IEC/EN 60947-5-1, IEC/EN 60204-1, EN 81-1, EN 50041, UL508, CSA C22.2 n° 14.

9 Key operated



TL2...

Order code	Contacts	Key shape	Qty per pkg	Wt
			n°	[kg]
Without reset button. Front key withdrawal.				
TL2 10 10	1NO+1NC Slow action	Straight	1	0.120
TL2 10 11		Angled	1	0.120
TL2 10 12		Angled "T"	1	0.120
TL2 10 13		Straight "T"	1	0.120

① Direct (positive) opening action; safety function according to IEC/EN 60947-5-1.

② Version with key withdrawal on the left or on the right is available; replace the last letter (A) of the order code respectively with S or D (e.g. TL2 10 10S - left or TL2 10 10D - right). For further assistance, consult Customer Service for information; see contact details on inside front cover.

③ The key is standard supplied.

Order code	Description	Qty per pkg	Wt
		n°	[kg]

Extra keys.

A 20746	Straight key	10	0.013
A 20747	Angled key	10	0.013
P 32753	Angled "T" key	10	0.008
P 32752	Straight "T" key	10	0.008
A 20748	Toggle key	2	0.085

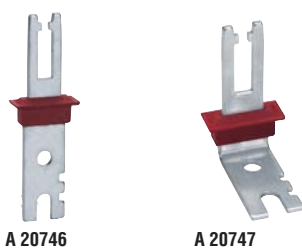

A 20748

Top push rod plunger



PLN...A...

Order code	Contacts	Degree of protection	Qty per pkg	Wt [kg]
		IEC	n°	
PLN A1 A	1NC	IP40	1	0.240
PLN A1 A W		IP65	1	0.240
PLN A2 A	2NC	IP40	1	0.240
PLN A2 A W		IP65	1	0.240
PLN C1 A	1NO	IP40	1	0.240
PLN C1 A W		IP65	1	0.240
PLN C2 A	2NO	IP40	1	0.240
PLN C2 A W		IP65	1	0.240
PLN U1 A	1NO+1NC	IP40	1	0.240
PLN U1 A W		IP65	1	0.240

① Direct (positive) opening action ⊖; safety function according to IEC/EN 60947-5-1.

Top roller push plunger



PLN...R...

Order code	Contacts	Degree of protection	Qty per pkg	Wt [kg]
		IEC	n°	
PLN A1 R	1NC	IP40	1	0.230
PLN A1 R W		IP65	1	0.230
PLN A2 R	2NC	IP40	1	0.230
PLN A2 R W		IP65	1	0.230
PLN C1 R	1NO	IP40	1	0.230
PLN C1 R W		IP65	1	0.230
PLN C2 R	2NO	IP40	1	0.230
PLN C2 R W		IP65	1	0.230
PLN U1 R	1NO+1NC	IP40	1	0.230
PLN U1 R W		IP65	1	0.230

① Direct (positive) opening action ⊖; safety function according to IEC/EN 60947-5-1.

Roller centre push lever



PLN...H

Order code	Contacts	Degree of protection	Qty per pkg	Wt [kg]
		IEC	n°	
PLN A1 H	1NC	IP40	1	0.270
PLN A1 H W		IP65	1	0.270
PLN A2 H	2NC	IP40	1	0.270
PLN A2 H W		IP65	1	0.270
PLN U1 H	1NO+1NC	IP40	1	0.270
PLN U1 H W		IP65	1	0.270

With offset roller.

PLN A1 HSB	1NC	IP40	1	0.290
PLN A1 HSB W		IP65	1	0.290
PLN A2 HSB	2NC	IP40	1	0.290
PLN A2 HSB W		IP65	1	0.290
PLN U1 HSB	1NO+1NC	IP40	1	0.290
PLN U1 HSB W		IP65	1	0.290

① Direct (positive) opening action ⊖; safety function according to IEC/EN 60947-5-1.



PLN...HSB W

Type	Travel [mm (in)]	Legend
PLN A1 A... PLN A1 R...	11-12 1.5 0.06" 11.5 0.45" [mm (in)]	□ open ■ closed
PLN A1 H... PLN A1 HSB...	11-12 2.4 0.09" 20 0.79" [mm (in)]	
PLN A2 A... PLN A2 R...	11-12 21-22 1.5 0.06" 6.5 0.25" [mm (in)]	
PLN A2 H... PLN A2 HSB...	11-12 21-22 2.4 0.09" 11.5 0.45" [mm (in)]	
PLN C1 A... PLN C1 R...	13-14 2.2 0.09" 11.5 0.45" [mm (in)]	
PLN C2 A... PLN C2 R...	13-14 23-24 4.2 0.16" 6.4 0.25" [mm (in)]	
PLN U1 A... PLN U1 R...	21-22 13-14 1.5 0.06" 11.5 0.45" 5.9 (0.23") [mm (in)]	
PLN U1 H... PLN U1 HSB...	21-22 13-14 2.4 0.09" 20 0.79" 10.4 (0.41") [mm (in)]	

General characteristics

The PLN types are for general purpose use. The extensive range of models with numerous of actuators and multiple contact configurations is the optimal solution to the diverse installation requirements.

Overall simple design, oversize contacts and choice materials ensure durable and safe operation. The metal alloy housing and resistant thermoplastic actuators warrant reliable heavy-duty features for any sort of operating conditions.

The PLN series limit switches are available with IEC IP40 or IP65 degree of protection; this characteristic is ensured by the use of appropriate sealing gasket. The IEC IP65 version is easily identified by the "W" suffix of its order code and can be used in adverse ambient conditions.

Operational characteristics

- Maximum operating rate: 3600 cycles/h
- Mechanical life: >10 million cycles
- IEC utilisation category:
 - DC13 duty: 10A 24V
 - AC15 duty: 5A 250V, 3A 400V
- IEC conventional thermal current I_{th}: 10A
- IEC rated insulation voltage U_i: 400VAC
- Contact resistance: <10mΩ
- Short-circuit backup protection: 10A gG/SC quick fuse
- Housing cable entry: PG11 (PLN...W types only complete with cable gland)
- Cable connection: screw terminal with clamp suitable for cables up to 2.5mm² / AWG 14
- Tightening torque for switch fixing: 2.5Nm / 22.1lbin
- Ambient conditions:
 - Operating temperature: -25...+70°C
 - Storage temperature: -40...+70°C
 - Pollution degree: 3
 - IEC degree of protection: IP40 / IP65 (see table indications).

Certifications and compliance

Certifications obtained: IMQ, EAC.
Compliant with standards: IEC/EN 60947-1, IEC/EN 60947-5-1, EN 81-1.

Latch and manual release



PLN A1 RAG

Order code	Contacts	Degree of protection	Qty per pkg	Wt
		IEC	n°	[kg]

Top roller push plunger.

PLN A1 RAG	1NC	IP40	1	0.220
PLN A1 RAG W	1NC	IP65	1	0.230

Direct (positive) opening action ; safety function according to IEC/EN 60947-5-1.

Manual reload and magnetic release

9



PL A1 AM

Order code	Contacts	Degree of protection	Qty per pkg	Wt
		IEC	n°	[kg]

Top push rod plunger.

PL A1 AM	1NC	IP40	1	0.245
PL A1 AM W	1NC	IP65	1	0.250

Top roller push plunger.

PL A1 RM	1NC	IP40	1	0.250
PL A1 RM W	1NC	IP65	1	0.260

Direct (positive) opening action ; safety function according to IEC/EN 60947-5-1.



PL A1 RM W

Bi-directional



PLN 978

Order code	Contacts	Degree of protection	Qty per pkg	Wt
		IEC	n°	[kg]

Rod plunger.

PLN 978	2NC independent	IP65	1	0.265
----------------	--------------------	------	---	-------

Direct (positive) opening action ; safety function according to IEC/EN 60947-5-1.

Type	Travel [mm (in)] (The arrows indicate the direction of operation)	open closed
PLN A1 RAG PLN A1 RAG W	$\begin{matrix} 1 & & 7 \\ 0.04'' & & 0.27'' \end{matrix}$ [mm (in)]	
PL A1 AM PL A1 AM W PL A1 RM PL A1 RM W	$\begin{matrix} 0.5 & & 8 \\ 0.02'' & & 0.31'' \end{matrix}$ [mm (in)]	
PLN 978	 [mm (in)]	

General characteristics

The PLN limit switches were initially made specifically for hoisting or lifting duty and then used in other diverse applications. The type with latch and manual release as well as the one with manual reload and magnetic release are designed so the switch remains opened after the switching of the NC contact. In the first instance, the contact closing is made by pushing the release button. In the second case, the reloading is obtained by pushing the shaft end or else pulling it from the top for the IP65 types.

The limit switches with dual operation can be replaced by two standard switches, for the stop control of moving mechanisms with two directions of running (e.g. automatic doors). It is equipped with two opposed operating mechanisms and one NC contact for each mechanism (i.e. 2NC).

The simple constructive design, oversize contacts and careful material combinations warrant safe and constant operation. The metal-alloy housing and the thermoplastic mechanism material of first-rate mechanical features assure reliability and durability with any type of operating condition.

Operational characteristics

- Maximum operating rate: 3600 cycles/h
- Mechanical life: >10 million cycles
- IEC utilisation category:
 - DC13 duty: 10A 24V
 - AC15 duty: 5A 250V, 3A 400V
- IEC conventional thermal current Ith: 10A
- IEC rated insulation voltage: 400VAC
- Contact resistance: <10mΩ
- Short-circuit backup protection: 10A gG/SC quick fuse
- Housing cable entry: PG11 (PL...W and PLN 978 types only complete with cable gland)
- Cable connection: screw terminal with clamp suitable for cables up to 2.5mm²/AWG 14
- Tightening torque for switch fixing: 2.5Nm/22.1lbin
- Ambient conditions:
 - Operating temperature: -25...+70°C
 - Storage temperature: -40...+70°C
 - Pollution degree: 3
 - IEC degree of protection: IP40 / IP65 (see table indications).

Certifications and compliance

Certifications obtained: IMQ, EAC.
Compliant with standards: IEC/EN 60947-5-1, IEC/EN 60204-1, EN 81-1.

Dimensions to EN 50047



RS1 13 10
RS2 13 10
RS3 13 10

Order code	Contacts	Ring material	Qty per pkg	Wt
			n°	[kg]
Without reset button.				
RS1 13 10	1NO+1NC Snap action	Steel	1	0.090
RS2 13 10	1NO+1NC Slow action	Steel	1	0.090
RS3 13 10	2NO Slow action	Steel	1	0.090

Type	▶ Forward travel of snap action contacts ◀ Return travel of snap action contacts	<input type="checkbox"/> open <input checked="" type="checkbox"/> closed
RS1 13...	▶ 21-22 13-14 ◀ 21-22 13-14	
RS2 13...	21-22 13-14	
RS3 13...	21-22 11-12	
TS1 13...	▶ 21-22 13-14 ◀ 21-22 13-14	
TL1 13...	21-22 13-14	

Dimensions to EN 50041



TS1 13 - TL1 10

Order code	Contacts	Ring material	Qty per pkg	Wt
			n°	[kg]
Without reset button.				
TS1 13 10	1NO+1NC Snap action	Steel	1	0.117
TL1 13 10	1NO+1NC Slow action	Steel	1	0.117

General characteristics

The RS and T series limit switches are designed and manufactured according to European standards for dimensions and operating characteristics.

The double-insulated housing of the limit switch is made of glass-reinforced self-extinguishing polyamide resin to protect internal circuits against shocks or impacts and in industrial environments, against accidental ingress of tools and accidental contact.

The contacts are dimensioned to ensure self cleaning of the silver-alloy contact surfaces.

Operational characteristics

- Maximum operating rate: 3600 cycles/h for RS...13 10; 1200 cycles/h for T...13 10
- Switching speed: 0.5...1.5m/s
- Mechanical life: >10 million cycles
- IEC utilisation category
 - DC13 duty: 1.5A 24V
 - AC15 duty: 6A 250V
- IEC conventional thermal current Ith: 10A
- IEC rated insulation voltage Ui: 250VAC
- Contact resistance: <10mΩ
- Short-circuit backup protection: 10A gG/SC quick fuse
- Operating force: 25N/5.6lb
- Cable entry: PG11 for RS...13 10; PG13.5 for T...13 10
- Cable connection: Self-releasing screw terminal
- Tightening torque:
 - Switch fixing: 2.5Nm / 22.1lbin
 - Contact terminals: 0.8Nm / 7lbin
 - Body lid screw fixing: 0.8Nm / 7lbin
- Conductor section: 1 or 2 2.5mm² max / 16-14 AWG
- Ambient conditions:
 - Operating temperature: -25...+70°C
 - Storage temperature: -40...+70°C
 - Pollution degree: 3
 - IEC degree of protection: IP65 for RS...13 10; IP66 for T...13 10.

Certifications and compliance

Certifications obtained: EAC, UL Listed for USA and Canada (cULus - File E93601), as Auxiliary Devices - Limit switches.

Compliant with standards: IEC/EN 60947-1, IEC/EN 60947-5-1, IEC/EN 60204-1, EN 81-1, EN 50041, UL508, CSA C22.2 n° 14.



PLN...AT...W

Order code	Contacts	Degree of protection	Operating force	Qty per pkg	Wt
		IEC	[N] / [lb]	n°	[kg]
Without reset button					
PLN U1 AT	1NO+1NC	IP40	10 / 2.2	1	0.240
PLN U1 AT W	①	IP65	10 / 2.2	1	0.240
PLN U1 AT25	1NO+1NC	IP40	25 / 5.6	1	0.240
PLN U1 AT25 W	①	IP65	25 / 5.6	1	0.240

① Direct (positive) opening action \ominus ; safety function according to IEC/EN 60947-5-1.

Type	Travel [mm (in)]	open closed
PLN U1 AT...	1.5 0.06" 11 0.43"	
P2L 8...	11-12 21-22	
P2L 10...	31-32 41-42 13-14 23-24	

General characteristics

The PLN and P2L types are limit switches for general use.

The simple constructive design, oversize contacts and careful material combinations warrant safe and constant operation. The metal-alloy housing and the thermoplastic mechanism material of first-rate mechanical features assure reliability and durability with any type of operating condition.

Operational characteristics

- Maximum operating rate: 3600 cycles/h
- Mechanical life: >10 million cycles
- IEC utilisation category
 - DC13 duty: 10A 24V
 - AC15 duty: 5A 250V; 3A 400V
- IEC conventional thermal current Ith: 10A for PLN types; 6A for P2L types
- IEC rated insulation voltage U_i : 400VAC
- Contact resistance: <10m Ω
- Short-circuit backup protection: 10A gG/SC quick fuse
- Cable entry: PG11 (PLN...W and P2L types only complete with cable gland)
- Cable connection: Self-releasing screw terminal suitable for cables up to 2.5mm²/AWG 14
- Tightening torque for switch fixing: 2.5Nm/2.21 lbin
- Ambient conditions:
 - Operating temperature: -25...+70°C
 - Storage temperature: -40...+70°C
 - Pollution degree: 3
 - IEC degree of protection: IP40 / IP65 (see order code table indications).

Certifications and compliance

Certifications obtained: IMQ.
Compliant with standards: IEC/EN 60947-1, IEC/EN 60947-5-1, EN 81-1.

9



P2L...

Order code	Contacts	Degree of protection	Operating force	Qty per pkg	Wt
		IEC	[N] / [lb]	n°	[kg]
Without reset button.					
P2L8 13 11	1NO+1NC	IP65	40 / 9	1	0.459
P2L8 13 12	①	IP65	120 / 27	1	0.459
P2L10 13 11	2NO+2NC	IP65	40 / 9	1	0.459
P2L10 13 12	①	IP65	120 / 27	1	0.459

① Direct (positive) opening action \ominus ; safety function according to IEC/EN 60947-5-1.

Limit, micro and foot switches

Rope-pull lever limit switches for emergency stopping, ISO 13850 compliant.

Accessories and spare parts



RS13 13 10

TL13 13 10

Order code	Contacts	Force	Qty per pkg	Wt
		[N]/[lb]	n°	[kg]
With reset button.				
RS13 13 10②	1NO + 1NC③	25/5.6	1	0.092
TL13 13 10②	1NO + 1NC③	25/5.6	1	0.125
PLN13 13 11	1NO + 1NC③	60/13.5	1	0.248
P2L13 13 11	1NO + 1NC③	40/9	1	0.459
P2L13 13 12	1NO + 1NC③	120/27	1	0.459
P2L15 13 11	2NO + 2NC③	40/9	1	0.459
P2L15 13 12	2NO + 2NC③	120/27	1	0.459

① Direct (positive) opening action \ominus ; safety function according to IEC/EN 60947-5-1.

② Dimensions according with EN50047.

③ Dimensions according with EN50041.

Example of wiring diagram

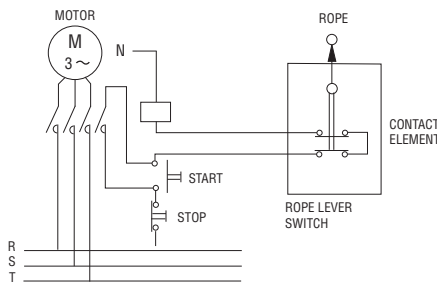

PLN 13 13 11



P2L...

Accessories and spare parts



P33032

P33033



P33034



P33035



P33036

Order code	Description	Qty per pkg	Wt
		n°	[kg]
Accessories.			
P33032	Rope terminal clamp, Ø5mm	10	0.023
P33033	Rope eye, Ø5mm	10	0.007
P33034	Turnbuckle M6x60	10	0.061
P33035	Eye bolt M8	10	0.030
P33036	Steel rope, Ø5mm①	100[m]	4.900

① The P33036 rope is sold in 100m/109.4yd roll; Ø5mm = Ø0.2".

Type	Travel [mm (in)]	Legend
		□ open ■ closed
RS... T...	11-12 21-22 0 [mm (in)] 6 (0.24")	
PLN...	11-12 21-22 0 [mm (in)] 8 (0.31")	
P2L13...	11-12 21-22 0 [mm (in)] 10 (0.39")	
P2L15...	31-32 41-42 13-14 23-24 0 [mm (in)] 10 (0.39")	

General characteristics

The rope-operated switches for emergency stop are mainly suitable for emergency stop or alarm systems for machinery which occupies a large space. This emergency stop can be achieved from any point when the rope is manually pulled each time.

The choice of the body, between plastic and metal, can satisfy the most diversified requirements for sturdiness and size.

Operational characteristics

- Maximum operating rate: 1800 cycles/h
- Mechanical life: 100,000 cycles
- IEC utilisation category
 - DC13 duty: 1.5A 24V (10A 24V only for PLN-P2L)
 - AC15 duty: 6A 250V (3A 400V only for PLN-P2L)
- IEC conventional thermal current I_{th}: 10A for RS, TL and PLN; 6A for P2L
- IEC rated insulation voltage U_i: 250VAC (400V for PLN-P2L)
- Contact resistance: <10mΩ
- Short-circuit backup protection: 10A gG/SC quick fuse
- Cable entry: PG11 for RS, PLN and P2L types (PLN and P2L complete with cable gland); PG13.5 for TL13 only
- Cable connection: Self-releasing screw terminal
- Tightening torque:
 - Switch fixing: 2.5Nm / 22.1lbin
 - Contact terminals: 0.8Nm / 7lbin
 - Body lid screw fixing: 0.8Nm / 7lbin
- Conductor section: 1 or 2 2.5mm² max / 16-14 AWG
- Ambient conditions:
 - Operating temperature: -25...+70°C
 - Storage temperature: -40...+70°C
 - Pollution degree: 3
 - IEC degree of protection: IP65 (T type: IP66).

Operation

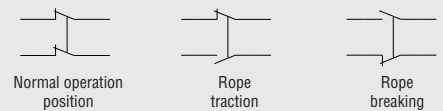

Certification and compliance

Certifications obtained: EAC for all; UL Listed for USA and Canada (cULus - File E93601), as Auxiliary Devices - Limit switches for RS13 and TL13 types only. Compliant with standards: IEC/EN 60947-1, IEC/EN 60947-5-1, IEC/EN 60204-1, ISO 13850; also UL508, CSA-C22.2 n° 14 for RS and TL types.

Limit, micro and foot switches

Plastic micro switches, K series.

Accessories



KS A1...

KS A2...



KS A3...

KS A4...



KS A9...

KS B1...



KS B2...

KS C1...



KS C2...

KS C3...



KS C9...

KS L1...

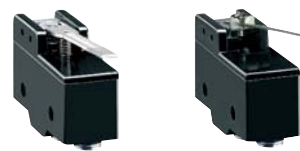

KS L2...

KS L3...



KSS C01

KSS CB2

Order code	Contacts	Terminals	Qty per pkg n°	Wt [kg]
------------	----------	-----------	-------------------	------------

TOP PUSH ROD - METAL PLUNGER. Pin.

KS A1 S	1NO/NC	Solder	10	0.031
KS A1 V	1NO/NC	Screw	10	0.031
KS A1 F	1NO/NC	Faston	10	0.032

TOP PUSH ROD - METAL PLUNGER. High rod plunger.

KS A2 S	1NO/NC	Solder	10	0.033
KS A2 V	1NO/NC	Screw	10	0.033
KS A2 F	1NO/NC	Faston	10	0.034

TOP PUSH ROD - METAL PLUNGER. Low rod plunger.

KS A3 S	1NO/NC	Solder	10	0.033
KS A3 V	1NO/NC	Screw	10	0.033
KS A3 F	1NO/NC	Faston	10	0.035

TOP PUSH ROD - METAL PLUNGER. M12 fixing head.

KS A4 S	1NO/NC	Solder	10	0.052
KS A4 V	1NO/NC	Screw	10	0.052
KS A4 F	1NO/NC	Faston	10	0.053

PUSH BUTTON.

KS A9 S	1NO/NC	Solder	10	0.034
KS A9 V	1NO/NC	Screw	10	0.034
KS A9 F	1NO/NC	Faston	10	0.035

TOP ROLLER PUSH PLUNGER. M12 fixing head.

KS B1 S	1NO/NC	Solder	10	0.057
KS B1 V	1NO/NC	Screw	10	0.057
KS B1 F	1NO/NC	Faston	10	0.058

TOP ROLLER PUSH PLUNGER. M12 fixing head, 90° roller.

KS B2 S	1NO/NC	Solder	10	0.057
KS B2 V	1NO/NC	Screw	10	0.057
KS B2 F	1NO/NC	Faston	10	0.060

ROLLER CENTRE PUSH LEVER. 26.6mm/1.05" long lever.

KS C1 S	1NO/NC	Solder	10	0.036
KS C1 V	1NO/NC	Screw	10	0.036
KS C1 F	1NO/NC	Faston	10	0.037

ROLLER CENTRE PUSH LEVER. 48.5mm/1.91" long lever.

KS C2 S	1NO/NC	Solder	10	0.037
KS C2 V	1NO/NC	Screw	10	0.037
KS C2 F	1NO/NC	Faston	10	0.038

ROLLER CENTRE PUSH LEVER. 38mm/1.5" long lever.

KS C3 S	1NO/NC	Solder	10	0.037
KS C3 V	1NO/NC	Screw	10	0.037
KS C3 F	1NO/NC	Faston	10	0.038

ROLLER CENTRE PUSH LEVER. One-way roller lever.

KS C9 S	1NO/NC	Solder	10	0.038
KS C9 V	1NO/NC	Screw	10	0.038
KS C9 F	1NO/NC	Faston	10	0.039

METAL LEVER. 63mm/2.48" long flat lever.

KS L1 S	1NO/NC	Solder	10	0.035
KS L1 V	1NO/NC	Screw	10	0.035
KS L1 F	1NO/NC	Faston	10	0.037

METAL LEVER. 54mm/2.13" long flat lever.

KS L2 S	1NO/NC	Solder	10	0.035
KS L2 V	1NO/NC	Screw	10	0.035
KS L2 F	1NO/NC	Faston	10	0.037

METAL LEVER. 168.3mm/6.63" long flat cylindrical lever.

KS L3 S	1NO/NC	Solder	10	0.037
KS L3 V	1NO/NC	Screw	10	0.037
KS L3 F	1NO/NC	Faston	10	0.038

ACCESSORIES. ❶

KSS C01	Terminal shroud		10	0.007
KSS CB2	Terminal shroud with conduit		10	0.015

❶ Suitable only for KS...V.

Operational characteristics

- Maximum operating rate: 240 cycles/min
- Switching speed: 0.01...1m/s
- Operating speed: 0.05...1m/s
- Electrical life: 500,000 cycles
- Mechanical life: 20 million cycles
- IEC conventional thermal current Ith: 15A
- UL/CSA and IEC/EN 60947-5-1 designation: A600 P300
- conductivity: 10mA 5V
- IEC rating: AC15 240VAC 3A
- IEC rated insulation voltage Ui: 250VAC
- Contact resistance: <15mΩ
- Body housing: polymer thermoplastic
- Operating force:
 - KS A1-KS A4 and KS B types: 2.5N/9oz
 - KS A9 and KS C3 types: 1.5N/5.4oz
 - KS C1 types: 1N/3.6oz
 - KS C2 and KS L2: 1.3N/4.7oz
 - KS C9 types: 1.7N/6.1oz
 - KS L1 types: 6.4N/23oz
 - KS L3 types: 0.1N/0.36oz
- Tightening torque:
 - For M12 head fixing: 4.9...6.9Nm/3.6...5.1lbf
 - For side screws: 0.6...1Nm/0.44...0.74lbf
 - For terminal screws: 0.7...1Nm/0.52...0.74lbf
- Ambient conditions:
 - Operating temperature: -25...+70°C
 - Storage temperature: -40...+70°C
 - Pollution degree: 3
 - IEC degree of protection: IP00 or IP20 with terminal shroud.

Certifications and compliance

Certifications obtained: EAC; UL Recognized for USA and Canada (File E172189) as Industrial Control Switches - Component; products having this type of marking are intended for use as components of complete workshop - assembled equipment. Compliance with standards: IEC/EN 60947-1, IEC/EN 60947-5-1, IEC/EN 61058-1, UL508, CSA C22.2 n° 14.



KG2 00 ...
KG2 20 ...



KR2 00 ...



KG1 10 ...



KR2 10 ...
KR2 11 ...



KGD 003 - KGD 004

- ① Direct (positive) opening action ⊕; safety function according to IEC/EN 60947-5-1.
- ② Consult Customer Service for information; see contact details on inside front cover.
- ③ A possible second contact block can be fitted; blocks with only 2 contacts in total can be used. See accessories below and contact blocks on page 9-16.

Order code Plastic body	Metal body	Model	Contacts	Qty per pkg	Wt
				n°	[kg]

ONE PEDAL FOOT SWITCHES. With free actuation.

KG1 00 S11 ③	KR1 00 S11 ③	Open	1NO+1NC Snap action ①	1	②
KG1 00 L11 ③	KR1 00 L11 ③	Open	1NO+1NC Slow action ①	1	②
KG2 00 S11 ③	KR2 00 S11 ③	With cover	1NO+1NC Snap action ①	1	②
KG2 00 L11 ③	KR2 00 L11 ③	With cover	1NO+1NC Slow action ①	1	②

With safety lever.

KG1 10 S11 ③	KR1 10 S11 ③	Open	1NO+1NC Snap action ①	1	②
KG1 10 L11 ③	KR1 10 L11 ③	Open	1NO+1NC Slow action ①	1	②
KG2 10 S11 ③	KR2 10 S11 ③	With cover	1NO+1NC Snap action ①	1	②
KG2 10 L11 ③	KR2 10 L11 ③	With cover	1NO+1NC Slow action ①	1	②
KG2 10 S22 ③	KR2 10 S22 ③	With cover	2NO+2NC Snap action ①	1	②

With pedal actuator lock.

KG1 20 S11 ③	KR1 20 S11 ③	Open	1NO+1NC Snap action ①	1	②
KG1 20 L11 ③	KR1 20 L11 ③	Open	1NO+1NC Slow action ①	1	②
KG2 20 S11 ③	KR2 20 S11 ③	With cover	1NO+1NC Snap action ①	1	②
KG2 20 L11 ③	KR2 20 L11 ③	With cover	1NO+1NC Slow action ①	1	②

With two-stage safety lever.

KG2 11 S22 ③	KR2 11 S22 ③	With cover	2NO+2NC 2-stage snap action ①	1	②
-----------------	-----------------	---------------	-------------------------------------	---	---

Order code Plastic body	Metal body	Model	Contacts (for each pedal)	Qty per pkg	Wt
				n°	[kg]

TWO PEDAL FOOT SWITCHES. With safety lever on both pedals.

KGD 001 ③	KRD 001 ③	Both w/cover	1NO+1NC Snap action ①	1	②
KGD 002 ③	KRD 002 ③	Both w/cover	2NO+2NC Snap action ①	1	②

Left pedal with free actuation and right pedal with safety lever.

KGD 003 ③	KRD 003 ③	Left open	1NO+1NC Snap action ①	1	②
		Right w/cover			
KGD 004 ④	KRD 004 ④	Left open	1NO+1NC Snap action ①	1	②
		Right w/cover			

General characteristics

The KG and KR foot switches are used to control machinery and other equipment, leaving the operator's hands free to do other functions. The sturdiness of the metal and plastic body and the wide range of the available versions provide the proper solution for each control need.

Main features are:

- Thermoplastic or metal version
- The plastic or metal body gives adequate robustness to the foot switch, for installation in all ambient and application conditions.
- Versions complete with or without pedal protection cover
- The cover assures protection against accidental foot switch operation, due to sudden tool or heavy material dropping or other shock or vibration. The type without cover, open version, is instead immediately accessible and is preferred when the most important pedal operation is to stop a machine.
- Versions with safety lever
- The safety mechanism prevents unintentional foot switch activation and excludes the pedal pressing if the operator's foot is not completely in place.
- Stable pedal base
- The foot switch is equipped with rubber feet and metal-reinforced base for a firm and non-sliding position and a more reliable and safe activation.

Operational characteristics

- Mechanical life: >10 million cycles
- Conventional thermal current Ith: 10A
- Designation to IEC/EN 60947-5-1:
 - A600 Q600 for KG types
 - A300 Q300 for KR types
- Tightening torque for contacts: 1Nm/0.74lbf
- Rated insulation voltage Ui:
 - 690VAC for KG types
 - 440VAC for KR types
- Rated impulse withstand voltage Uimp:
 - 6kV for KG types
 - 4kV for KR types
- Class II insulation (KG types only)
- Contact resistance: <10mΩ
- Short-circuit backup protection: 10A gG fuse
- Cable connection: self-releasing screw terminal
- Housing:
 - KG types - Self-extinguishing double-insulation polymer thermoplastic
 - KR types - Aluminium-zinc alloy
- Cable entry: M20
- Ambient conditions:
 - Operating temperature: -25...+70°C
 - Storage temperature: -40...+70°C
 - Pollution degree: 3
- IEC degree of protection:
 - IP20 for terminals
 - IP54 for body housing
 - IP65 available on request (add the letter S at the end of the order code. E.g. KG1 00 S11 S).

Certifications and compliance

Certifications obtained: EAC for foot switches and cURus for contacts only (see page 9-16 for details).
Compliant with standards: IEC/EN 60947-1, IEC/EN 60947-5-1, IEC/EN 60204-1, IEC/EN 60447.

Accessories



KX P...



KX P03

- ④ A possible second contact block can be fitted on the left-hand pedal; blocks with only 2 contacts in total can be used. See accessories below and contact blocks on page 9-16.

Order code	Description	Qty per pkg	Wt
		n°	[kg]

Accessories.

KGX 01	Kit of elements to activate 2° contact block ④	10	0.039
KGX 02	Contact block mounting bracket	10	0.022

Cable glands and cable conduit.

KX P01	M20 cable gland	50	0.009
KX P02	PG13.5 cable gland	50	0.009
KX P03	M20 rubber cable conduit	50	0.004

General characteristics

The cable glands are in plastic with either M20 or PG13.5 thread and provide to keep the cable in place and maintain the proper IP protection of the switch after installation.

Operational characteristics for cable gland

- Material: Self-extinguishing polyamide
- IEC degree of protection: IP68
- Gland seal with cable diameter: 6...12mm/0.24"...0.47"

Certifications and compliance

Certifications obtained: EAC.
Compliant with standards: EN 50262, UL508.

LIMIT SWITCHES K SERIES

**KB A1...
KM A1...**

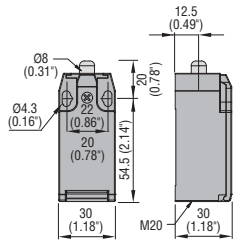

**KC A1
KN A1**

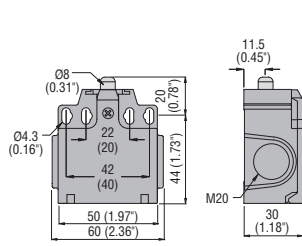

**KB B1... - KB B2...
KM B1... - KM B2...**

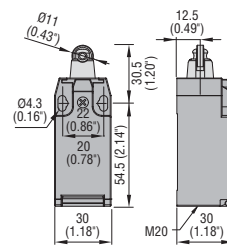

**KC B1... - KC B2...
KN B1... - KN B2...**

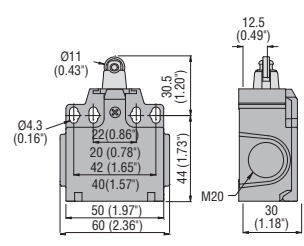

**KB C1... - KB C2...
KM C1... - KM C2...**

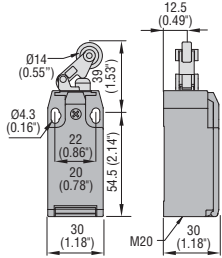

**KC C1... - KC C2...
KN C1... - KN C2...**

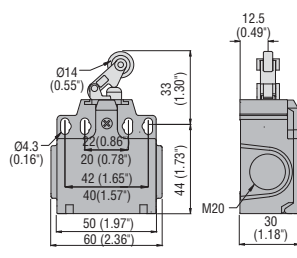

**KB D1... - KB D2...
KM D1... - KM D2...**

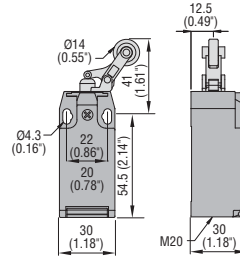

**KC D1... - KC D2...
KN D1... - KN D2...**

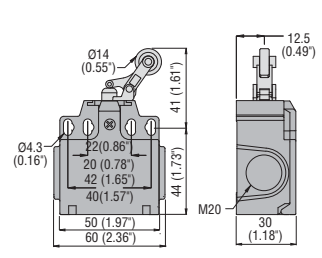

**KB E1... - KB E2...
KM E1... - KM E2...**

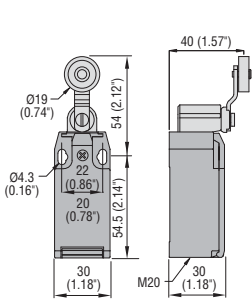

**KC E1... - KC E2...
KN E1... - KN E2...**

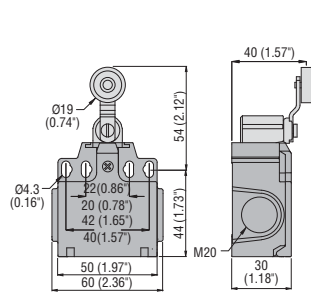

**KB E3...
KM E3...**

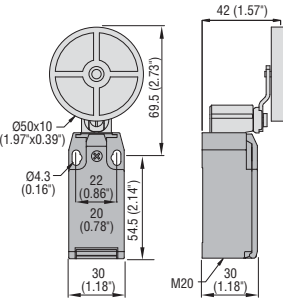

**KC E3...
KN E3...**

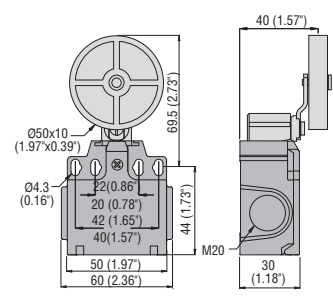

**KB F1... - KB F2...
KM F1... - KM F2...**

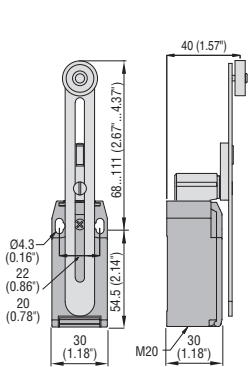

**KC F1... - KC F2...
KN F1... - KN F2...**

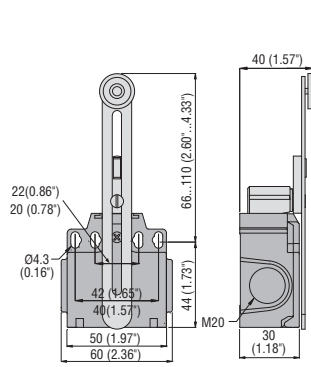

**KB F3...
KM F3...**

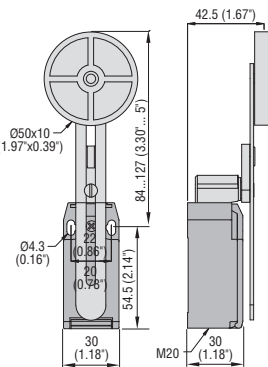

**KC F3...
KN F3...**

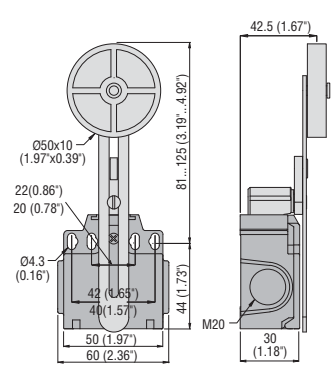

**KB F4...
KM F4...**

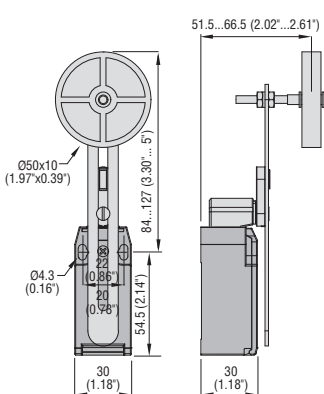

**KC F4...
KN F4...**

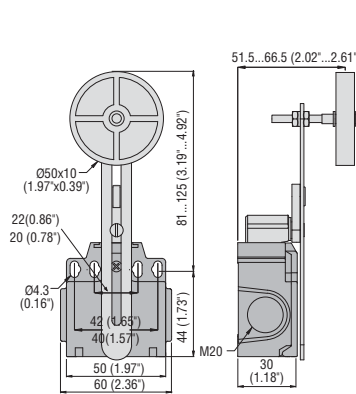

**KB H1...
KM H1...**

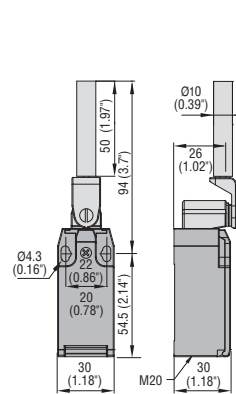

**KC H1...
KN H1...**

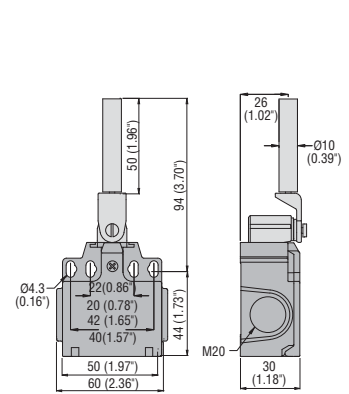

LIMIT SWITCHES

KB L1... - KB L2...
KM L1... - KM L2...

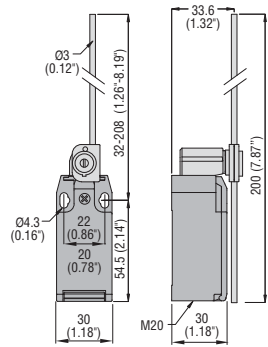

KC L1... - KC L2...
KN L1... - KN L2...

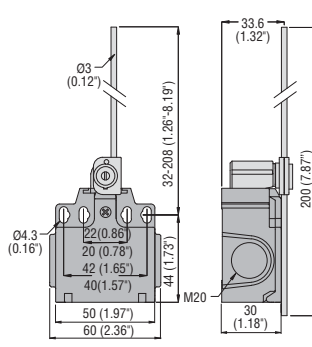

KB M1... - KB M2...
KM M1... - KM M2...

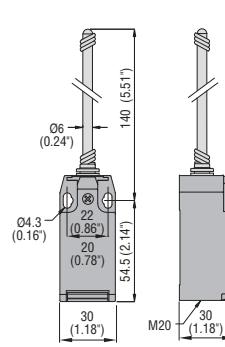

KC M1... - KC M2...
KN M1... - KN M2...

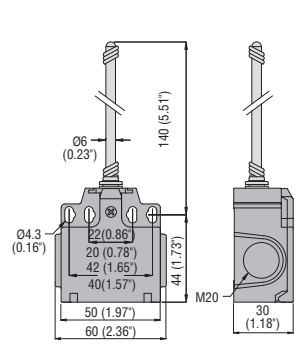

KB P1...
KM P1...

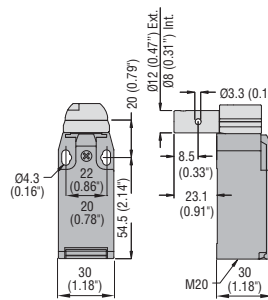

KB P2...
KM P2...

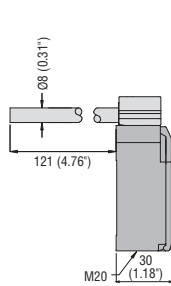

KB P3...
KM P3...

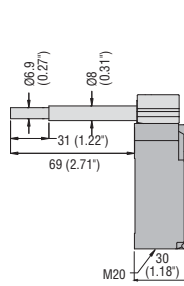

KC P1...
KN P1...

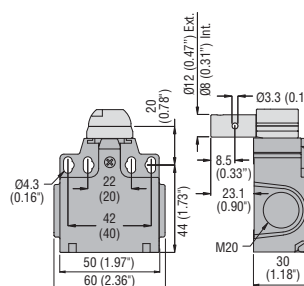

KC P2...
KN P2...

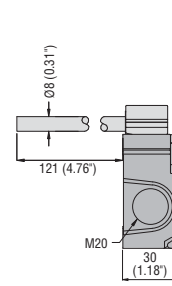

KC P3...
KN P3...

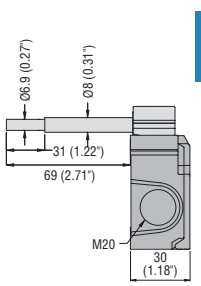

KB Q1 L...
KM Q1 L...

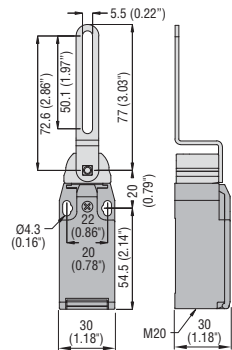

KC Q1 L...
KN Q1 L...

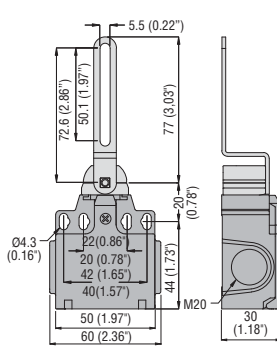

KB N1... - KB N2...
KM N1... - KM N2...

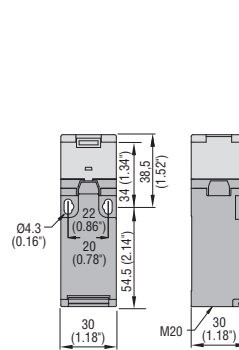

KC N...

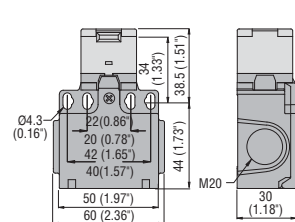

Keys
KX N1

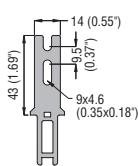

KX N2

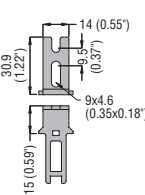

KX N3

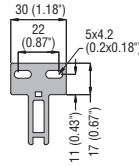

KX N4

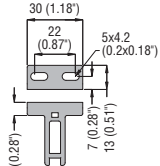

KX N5

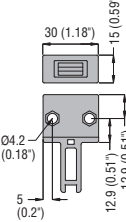

Cable glands
KX P01

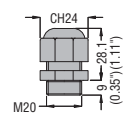

CH = Spanner/Wrench

KX P02

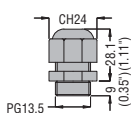

CH = Spanner/Wrench

Cable conduit
KX P03

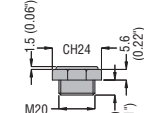

CH = Spanner/Wrench

PREWIRED METAL LIMIT SWITCHES, K SERIES

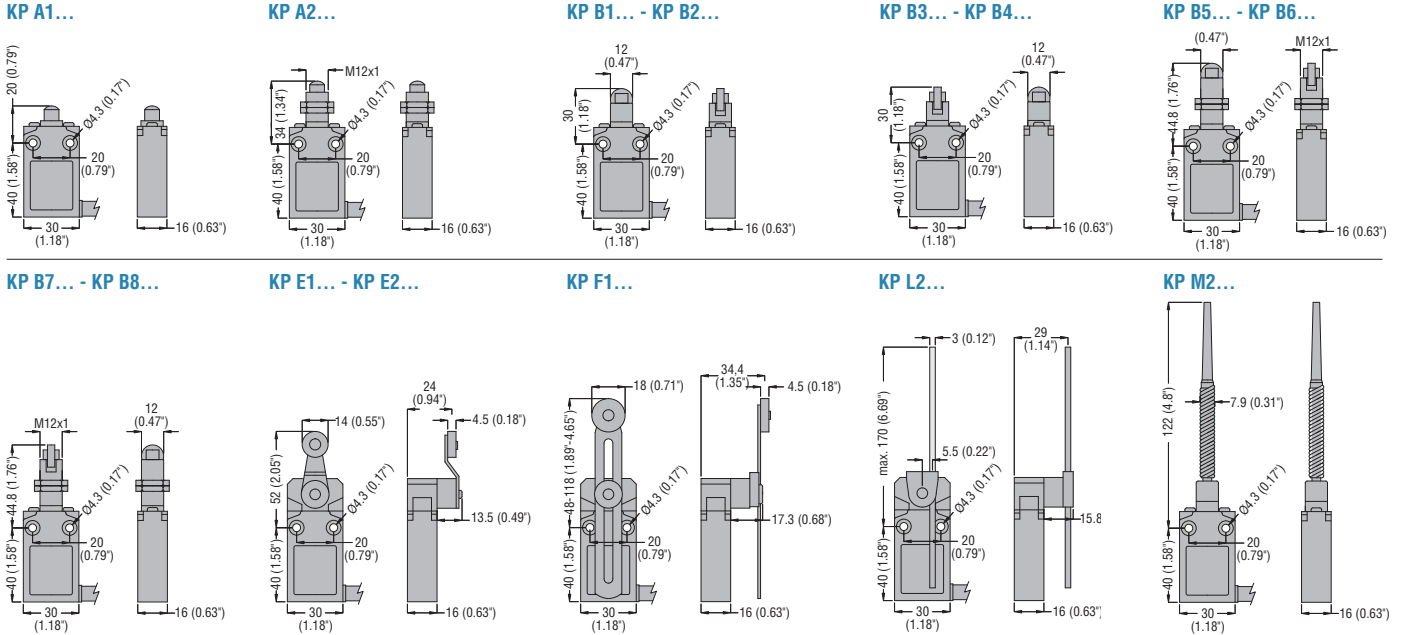

PLASTIC LIMIT SWITCHES, T SERIES

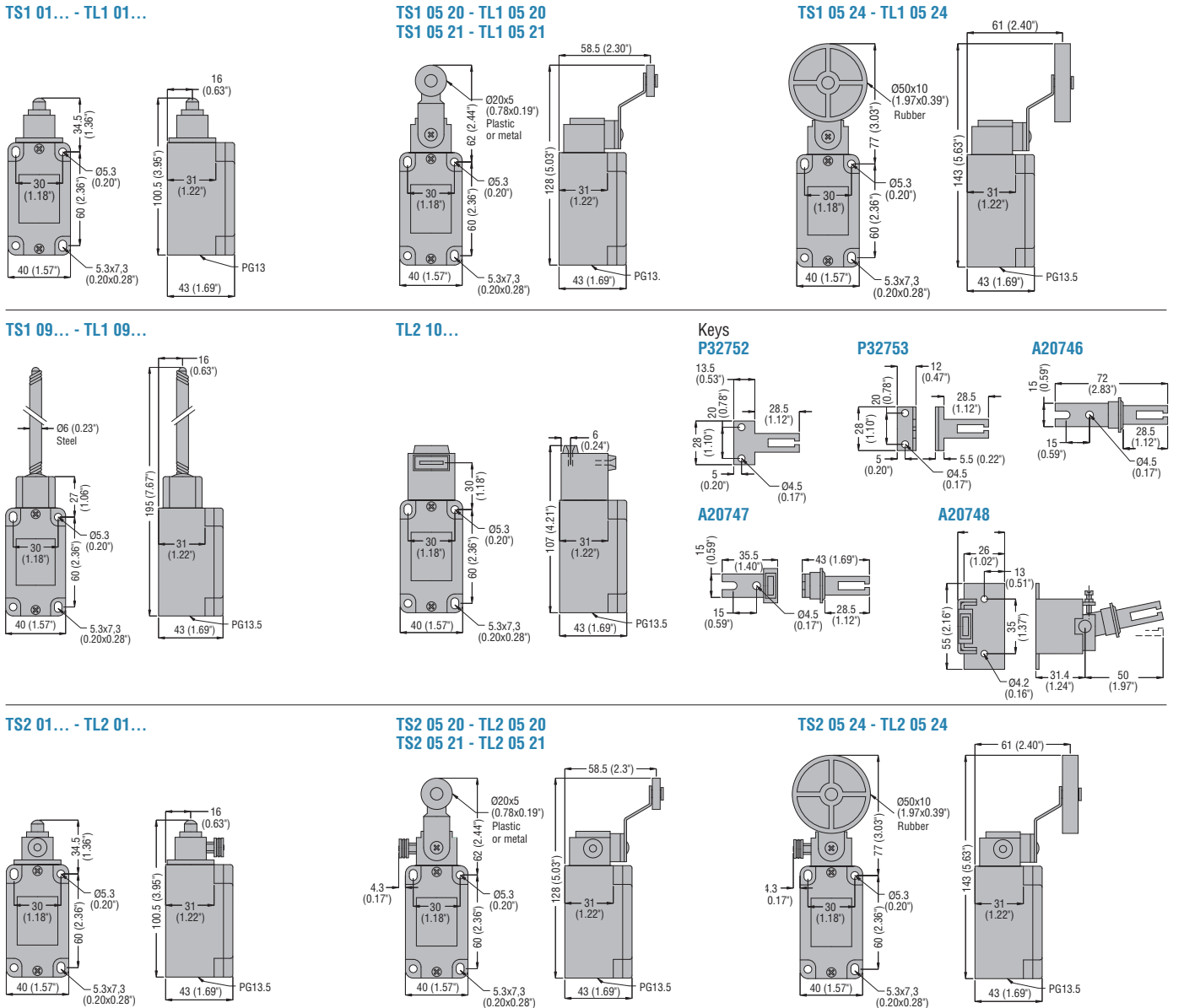

METAL LIMIT SWITCHES, PL SERIES

PLN...A

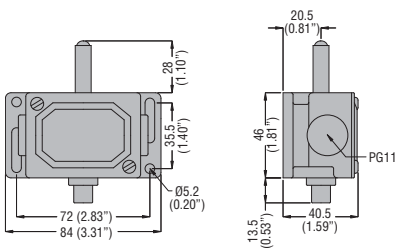

PLN...AW

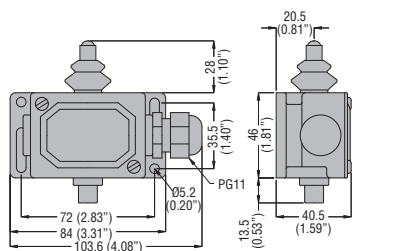

PLN...R

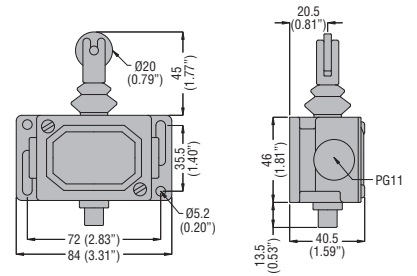

PLN...RW

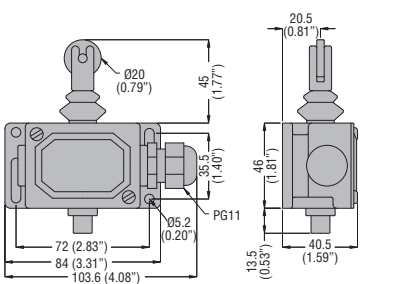

PLN...H

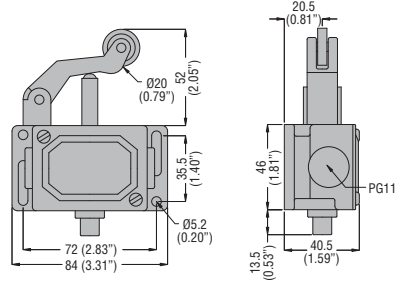

PLN...HW

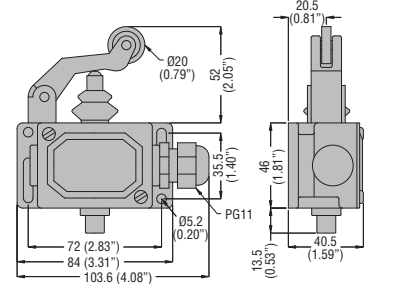

PLN...HSB

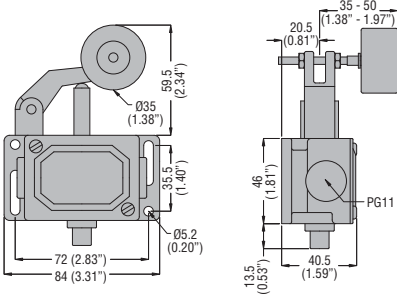

PLN...HSBW

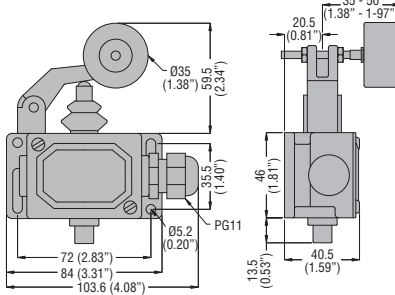

PLN A1 RAG

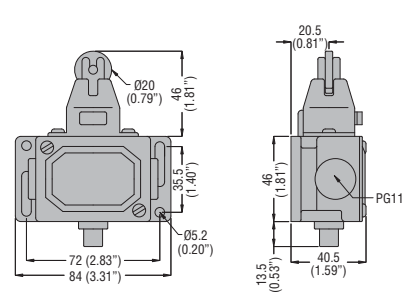

PLN A1 RAG W

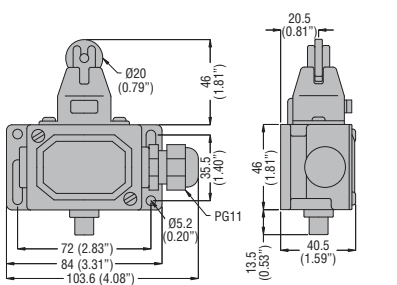

PLN A1 AM

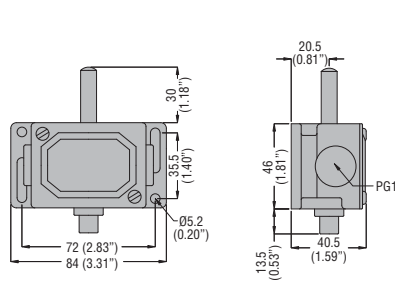

PL A1 AM W

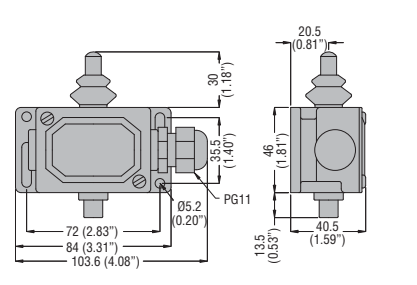

PL A1 RM

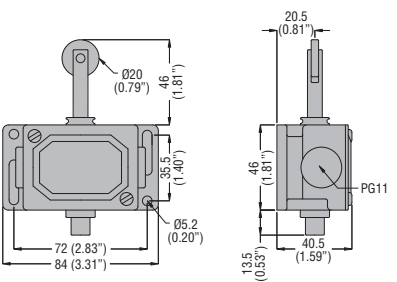

PL A1 RMW

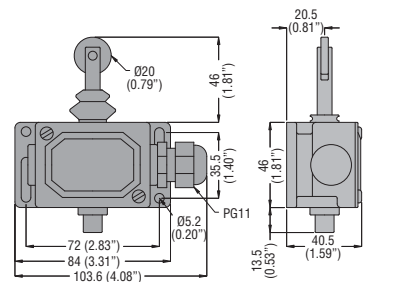

PLN 978

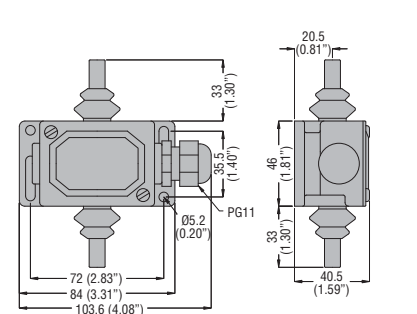

ROPE-PULL LEVER LIMIT SWITCHES FOR NORMAL STOPPING

RS1 13... - RS3 13...

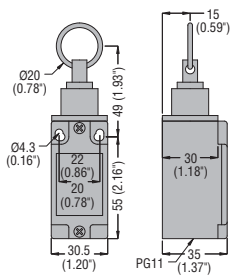

TS1 13... - TL1 13...

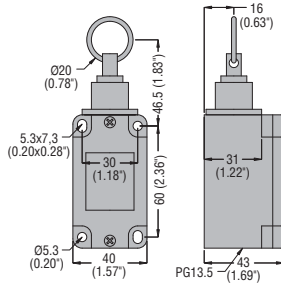

PLN...AT

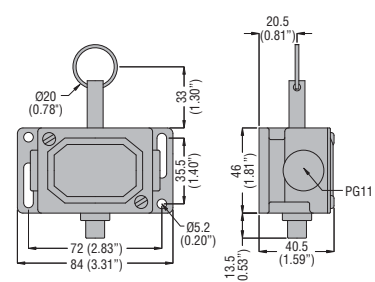

PLN...ATW

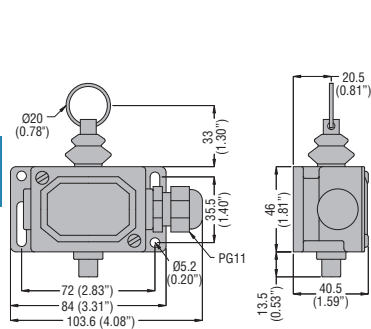

P2L...

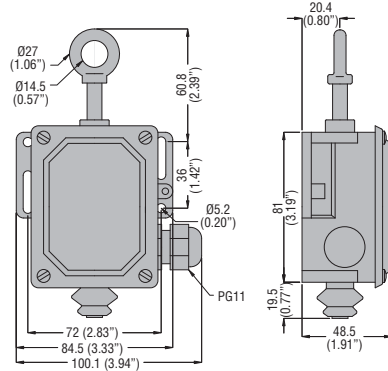

9

ROPE-PULL SAFETY LIMIT SWITCHES, ISO 13850 COMPLIANT

RS13 13 10

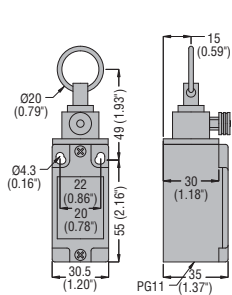

TL13 13 10

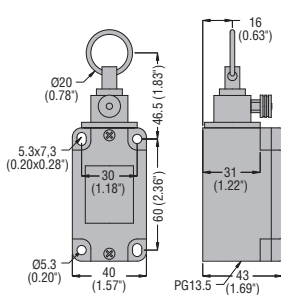

PLN13 13 11

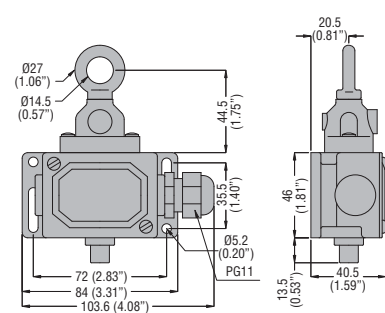

P2L 13... - P2L 15...

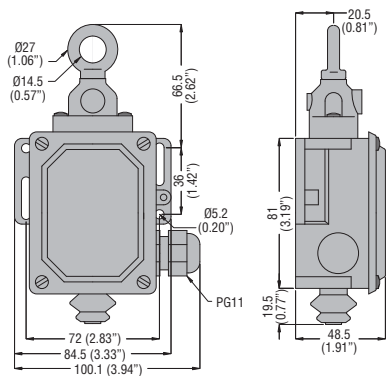

MICRO SWITCHES, K SERIES

KS A1...

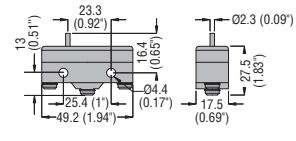

KS A2...

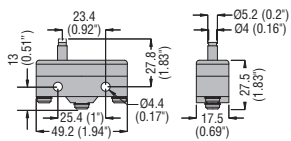

KS A3...

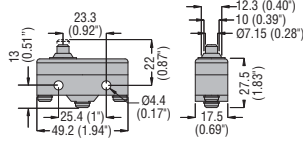

KS A4...

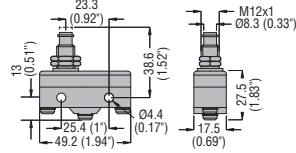

KS A9...

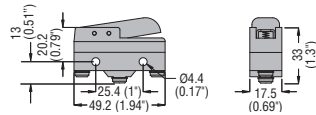

KS B1...

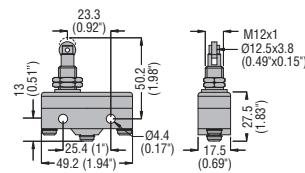

KS B2...

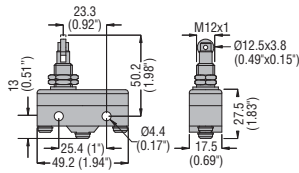

KS C1...

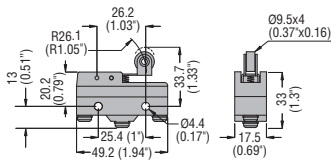

KS C2...

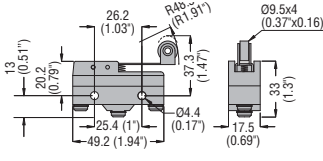

KS C3...

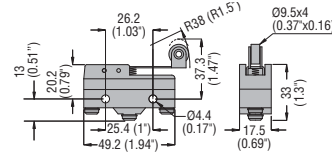

KS C9...

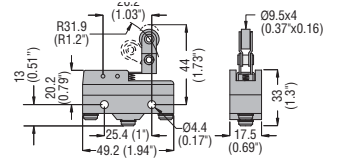

KS L1...

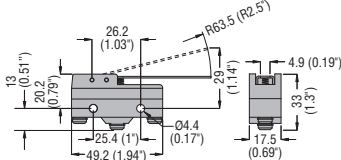

KS L2...

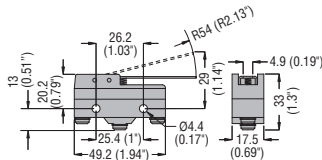

KS L3...

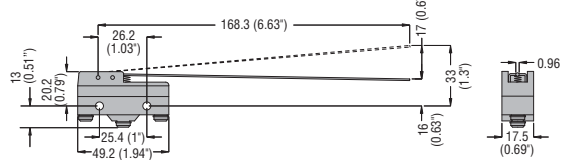

TERMINAL SHROUD

KSS C01

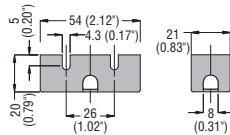

KSS CB2

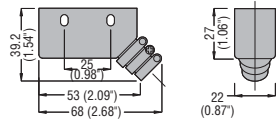

FOOT SWITCHES, K SERIES

KG1

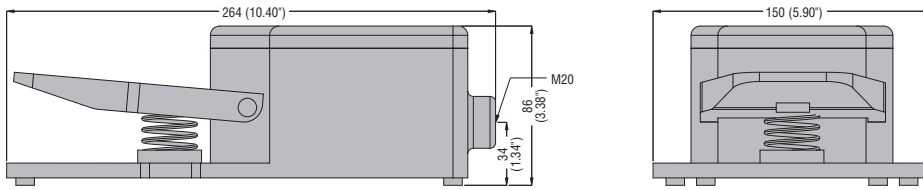

KG2

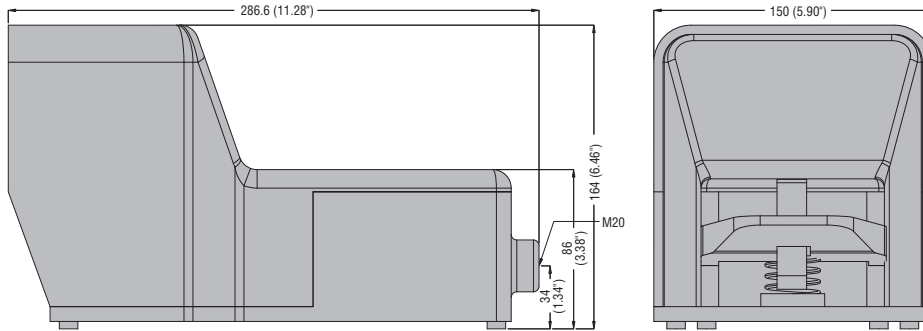

KR1

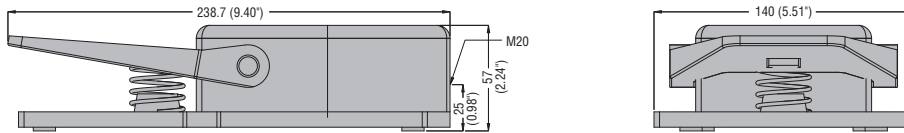

KR2

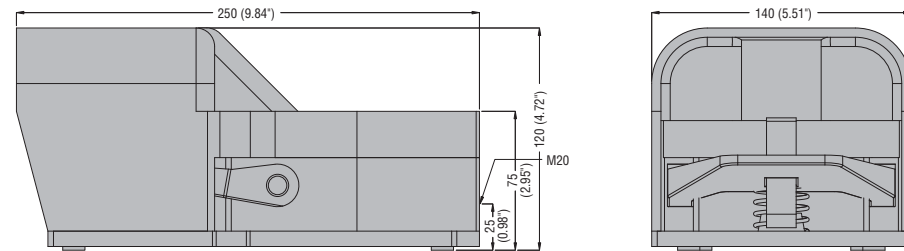

KGD

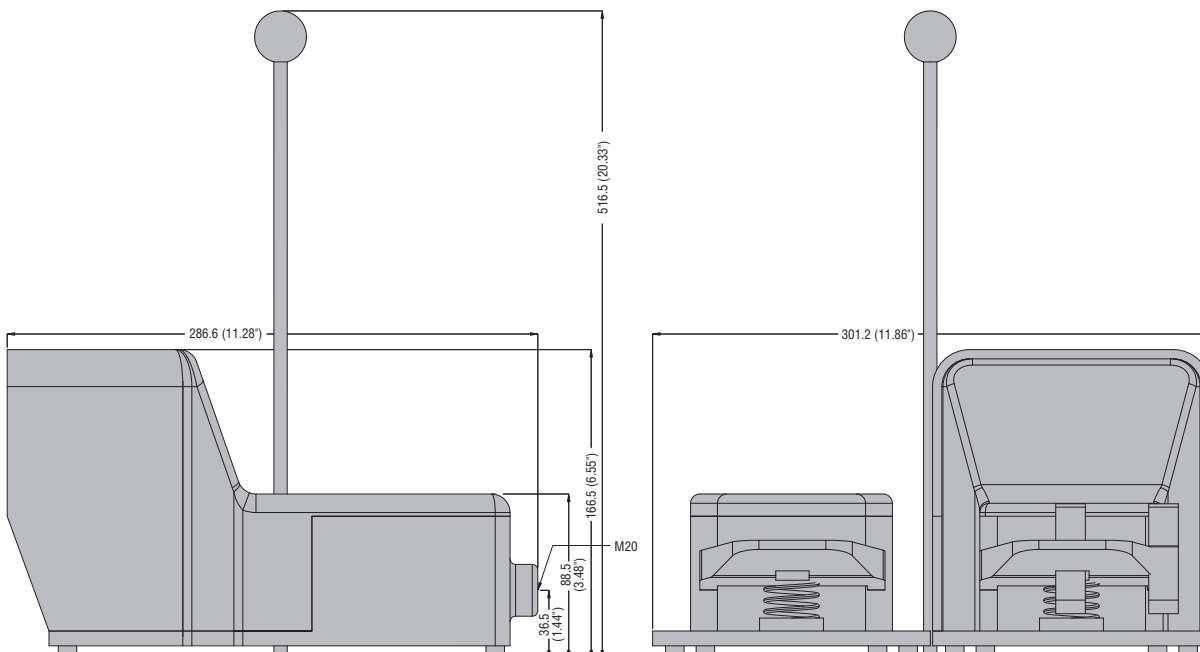

9

LIMIT SWITCHES, KB - KM - KC - KN TYPE

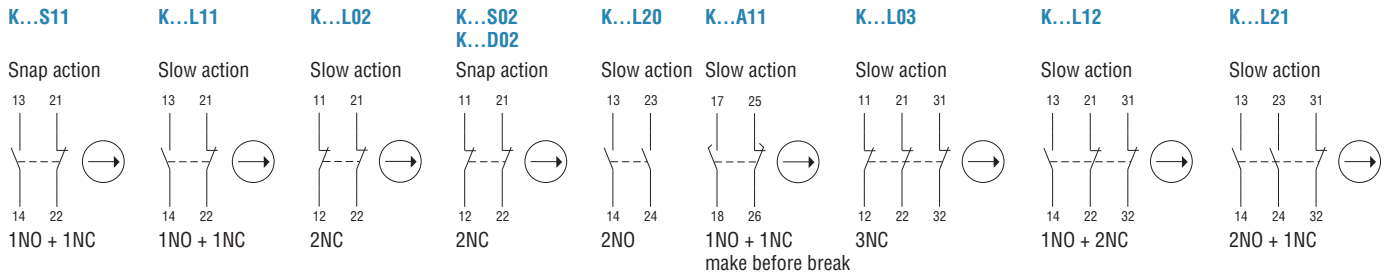

LIMIT SWITCHES, KP TYPE

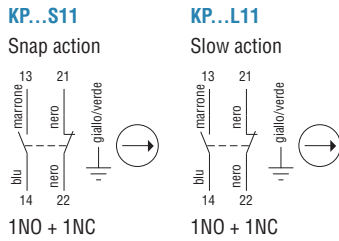

LIMIT SWITCHES, T TYPE

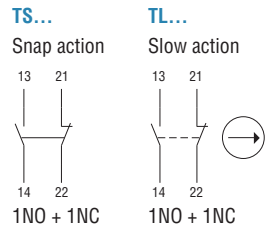

LIMIT SWITCHES, PL TYPE

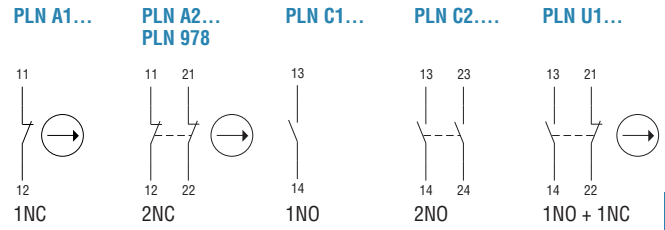

LIMIT SWITCHES FOR NORMAL STOPPING

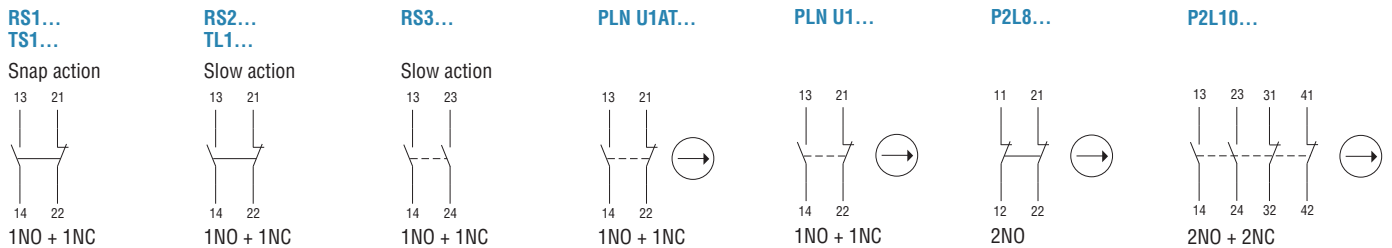

LIMIT SWITCHES FOR EMERGENCY STOPPING

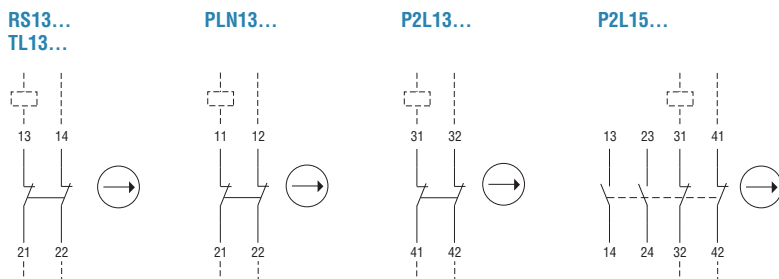

MICRO SWITCHES, KS TYPE

